

JVC

SERVICE MANUAL

AV INTEGRATED AMPLIFIER

AX-V5BK

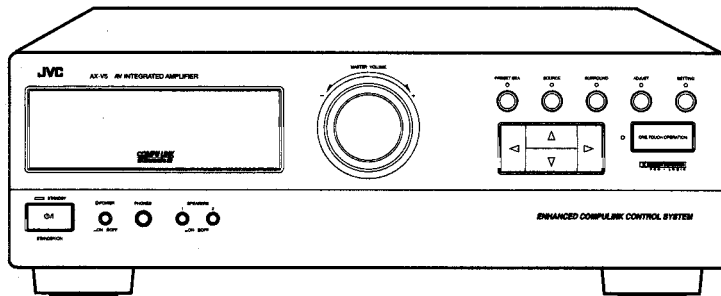
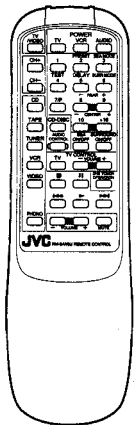

Area Suffix

BS	the U.K
EF	Continental Europe Except Germany
EN	Nordic Countries
G	...	Germany
US	...	Singapore
UT	...	Taiwan
U	...	Universal Except All of Above

COMPU LINK
/// Remote ///

Contents

Safety Precautions	1-2
Instruction Book	1-3
Description of Major LSIs	2-1
Internal Connection For FL Display Tube.....	2-8
Disassembly Procedures	2-9

Adjustment Procedures	2-11
Block Diagrams	2-12
Printed Circuit Boards	2-13
Schematic Diagrams	2-17
Parts List.....	3-1

Safety Precautions

1. The design of this product contains special hardware and many circuits and components specially for safety purposes. For continued protection, no changes should be made to the original design unless authorized in writing by the manufacturer. Replacement parts must be identical to those used in the original circuits. Services should be performed by qualified personnel only.
2. Alterations of the design or circuitry of the product should not be made. Any design alterations of the product should not be made. Any design alterations or additions will void the manufacturer's warranty and will further relieve the manufacture of responsibility for personal injury or property damage resulting therefrom.
3. Many electrical and mechanical parts in the products have special safety-related characteristics. These characteristics are often not evident from visual inspection nor can the protection afforded by them necessarily be obtained by using replacement components rated for higher voltage, wattage, etc. Replacement parts which have these special safety characteristics are identified in the Parts List of Service Manual. Electrical components having such features are identified by shading on the schematics and by (Δ) on the Parts List in the Service Manual. The use of a substitute replacement which does not have the same safety characteristics as the recommended replacement parts shown in the Parts List of Service Manual may create shock, fire, or other hazards.
4. The leads in the products are routed and dressed with ties, clamps, tubings, barriers and the like to be separated from live parts, high temperature parts, moving parts and/or sharp edges for the prevention of electric shock and fire hazard. When service is required, the original lead routing and dress should be observed, and it should be confirmed that they have been returned to normal, after re-assembling.
5. Leakage current check (Electrical shock hazard testing)
After re-assembling the product, always perform an isolation check on the exposed metal parts of the product (antenna terminals, knobs, metal cabinet, screw heads, headphone jack, control shafts, etc.) to be sure the product is safe to operate without danger of electrical shock.

Do not use a line isolation transformer during this check.

- Plug the AC line cord directly into the AC outlet. Using a "Leakage Current Tester", measure the leakage current from each exposed metal parts of the cabinet, particularly any exposed metal part having a return path to the chassis, to a known good earth ground. Any leakage current must not exceed 0.5mA AC (r.m.s.).

● Alternate check method

Plug the AC line cord directly into the AC outlet. Use an AC voltmeter having, 1,000 ohms per volt or more sensitivity in the following manner. Connect a 1,500 Ω 10 W resistor paralleled by a 0.15 μ F AC-type capacitor between an exposed metal part and a known good earth ground.

Measure the AC voltage across the resistor with the AC voltmeter.

Move the resistor connection to each exposed metal part, particularly any exposed metal part having a return path to the chassis, and measure the AC voltage across the resistor.

Now, reverse the plug in the AC outlet and repeat each measurement. Any voltage measured must not exceed 0.75 V AC (r.m.s.). This corresponds to 0.5 mA AC (r.m.s.).

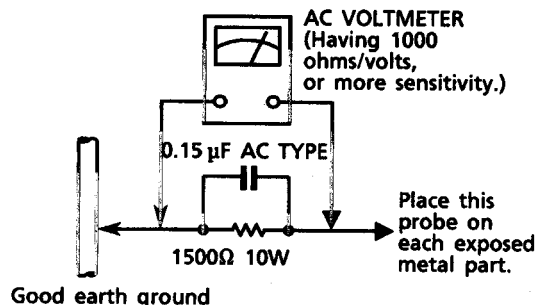

Warning

1. This equipment has been designed and manufactured to meet international safety standards.
2. It is the legal responsibility of the repairer to ensure that these safety standards are maintained.
3. Repairs must be made in accordance with the relevant safety standards.
4. It is essential that safety critical components are replaced by approved parts.
5. If mains voltage selector is provided, check setting for local voltage.

Switches, Buttons and Controls 2

Getting Started..... 3

Before Installation..... 3

Checking the Supplied Accessories 3

Connecting the Speakers 4

Connecting Audio/Video Components 6

Connecting Audio Components for the COMPU LINK-3 Remote Control System 7

Connecting the Power Cord 8

Putting Batteries in the Remote Control 8

Basic Operations..... 9

Turning the Power On and Off (Standby)..... 9

Selecting the Source to Play 9

Selecting the Front Speakers 10

Adjusting the Volume 10

Muting the Sound 10

Recording a Source 11

Listening with Headphones 11

Basic Settings 12

Adjusting the Front Speaker Output Balance 12

Listening at Low Volume (Loudness) 12

Using the Sleep Timer 12

Selecting the Center Speaker Size 13

One Touch Operation..... 14

About the One Touch Operation 14

Using the One Touch Operation 14

Using the Preset SEA Modes 15

Selecting Your Favorite SEA Mode 15

Using the Surround Processor 17

Using JVC's Hall Surround 17

Speaker Arrangements for Dolby Surround 19

Preparing for Dolby Surround 20

Using Dolby Surround 23

COMPU LINK Remote Control System 24

Using the Remote Control..... 25

Troubleshooting 27

Specifications 28

Switches, Buttons and Controls

Become familiar with the buttons and controls on the amplifier before use.

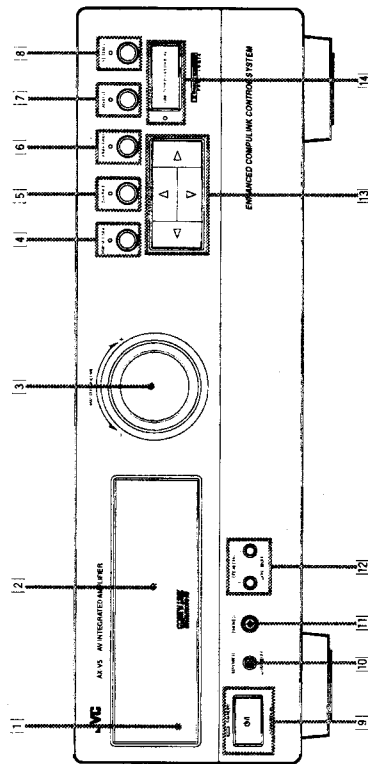

Refer to the pages in parentheses for details.

Front Panel

- 11 Remote sensor
- 2 Display (9)
- 3 MASTER VOLUME control (10)
- 4 PRESET SEA button and lamp (15)
- 5 SOURCE button and lamp (9)
- 6 SURROUND button and lamp (17, 20, 23)
- 7 ADJUST button and lamp (18, 20)
- 8 SETTING button and lamp (12)
- 9 STANDBY/ON button and lamp (12)
- 10 POWER switch (8)
- 11 PHONES jack (11)
- 12 SPEAKERS 1/2 buttons (10)
- 13 Control Δ / ∇ / \leftarrow / \rightarrow buttons
- 14 ONE TOUCH OPERATION button and lamp (14)
- 15 TV/VIDEO button (26)
- 16 CH (+/-) buttons (26)
- 17 CD-DISC button (25)
- 18 AUDIO CONTROL button (16, 18, 22, 23)
- 19 Source buttons (CD, TAPE, TUNER, VCR, VIDEO, PHONO) (9, 23, 26)
- 20 VOLUME (+/-) buttons (10)
- 21 \odot /(Standby/On) buttons (TV, VCR, AUDIO) (9, 26)
- 22 10 keys/Audio control buttons (16, 18, 22, 23, 25)
- 23 SEA ON/OFF button (16)
- 24 SURROUND ON/OFF button (18, 22, 23)
- 25 TV CONTROL buttons (TV, VOLUME (+/-)) (26)
- 26 ONE TOUCH OPERATION button (14)
- 27 Operating buttons for JVC audio/video components (25, 26)
- 28 MUTE button (10)

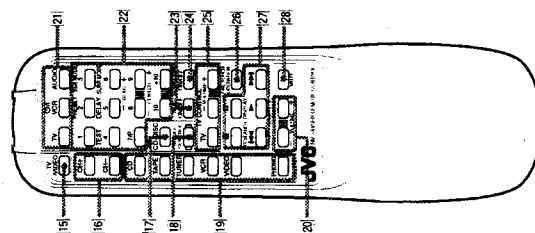

Getting Started

This section explains how to connect stereo components and speakers to the amplifier, and how to connect the power supply.

Before Installation

- General**
- Be sure your hands are dry.
 - Turn the power off to all components.
 - Read the manuals supplied with the components you are going to connect.

- Locations**
- Install the amplifier in a location that is level and protected from moisture.
 - The temperature around the amplifier must be between -5° and 35° C (23° and 95° F).
 - Make sure there is good ventilation around the amplifier. Poor ventilation could cause overheating and damage the amplifier.

- Handling the amplifier**
- Do not insert any metal object into the amplifier.
 - Do not disassemble the amplifier or remove screws, covers, or cabinet.
 - Do not expose the amplifier to rain or moisture.

Checking the Supplied Accessories

Check to be sure you have all of the following items, which are supplied with the amplifier. The number in the parentheses indicates quantity of the pieces supplied.

- Remote Control (1)
 - Batteries (2)
- If anything is missing, contact your dealer immediately.

Connecting the Speakers

- You can connect the following speakers:
- Two sets of front speakers to produce normal stereo sound
 - One set of rear speakers to enjoy the surround effect
 - One center speaker to produce more effective surround effect (to make human voices outstanding)
 - One subwoofer to enhance the bass

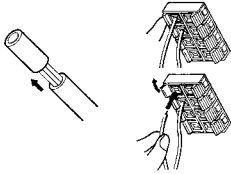

For each speaker (except for subwoofer), connect one end of the speaker signal cable (not supplied) to the speaker terminal on the rear panel and the other end to the speaker. (For connecting a subwoofer, see page 6).

1. Open each terminal.
2. Insert the end of the speaker signal cable as shown (be sure to remove the insulation at the end of each wire first).
3. Close the terminals to clamp the speaker signal cables firmly in place.
4. Connect the black (-) and red (+) terminals on the rear panel to the black (-) and red (+) terminals marked on the speakers.

CAUTION:
When connecting speakers, use speakers with the same SPEAKER IMPEDANCE indicated by the speaker terminals.

Connecting the front speakers

Connect the front speakers to the FRONT SPEAKERS terminals.

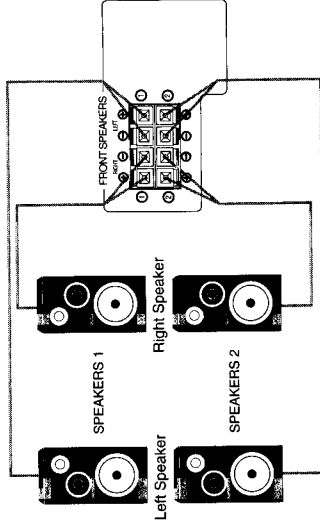

Connecting the rear and center speakers

Connect rear speakers to the REAR SPEAKERS terminals and a center speaker to the CENTER SPEAKER terminals.

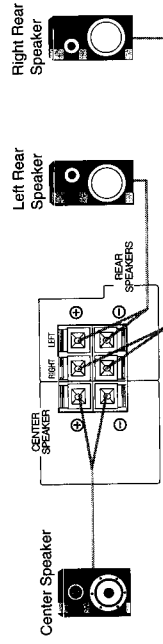

Note:
When you connect rear speakers, make sure that both left and right speakers are connected; otherwise, no sound will come out of the rear speakers.

About the speaker impedance of the speakers

CAUTION:

When connecting speakers, use speakers with the same **SPEAKER IMPEDANCE** indicated by the speaker terminals.

Notes:

- The required speaker impedance of the front speakers does not differ depending on whether both the **FRONT SPEAKERS (1)** and **FRONT SPEAKERS (2)** terminals are used or only one of them is used.
- The required speaker impedance of the front speakers differs depending on whether or not a center and/or rear speakers are connected at the same time. Since there are four possible speaker connections with the amplifier, check which one fits your case and use the speaker with the impedance described below.

CASE 1 When you connect only front speakers



Use front speakers with 4 — 16 ohm impedance.

CASE 2 When you connect front speakers and a center speaker

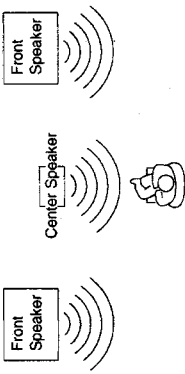

Use the following speakers:

- Front speakers: 8 — 16 ohm impedance
- Center speaker: 8 — 16 ohm impedance

CASE 3 When you connect front and rear speakers

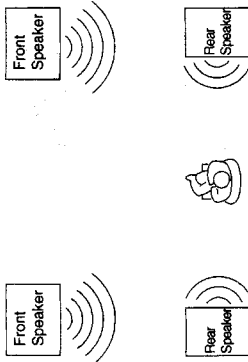

Use the following speakers:

- Front speakers: 8 — 16 ohm impedance
- Rear speakers: 8 — 16 ohm impedance

CASE 1 When you connect front and rear speakers as well as a center speaker

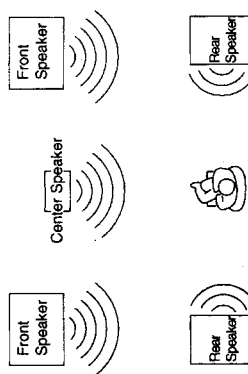

Use the following speakers:

- Front speakers: 8 — 16 ohm impedance
- Rear speakers: 8 — 16 ohm impedance
- Center speaker: 8 — 16 ohm impedance

Connecting the subwoofer speaker

Connect the input jack of a powered subwoofer to the **SUBWOOFER OUT** jack on the rear panel, using a cable with RCA pin plugs.



Powered subwoofer

Connecting Audio/Video Components

You can connect the following components to the amplifier using cables with RCA pin plugs.

Audio Components	Video Components
• Turntable	• VCR
• CD player	• Video disc player
• Cassette deck	• TV
• Tuner	

Note:

Any turntables incorporating a small output cartridge such as an MC (moving-coil type) must be connected to the amplifier through a commercial head amplifier or step-up transformer. Direct connection may result in insufficient volume.

Audio component connections

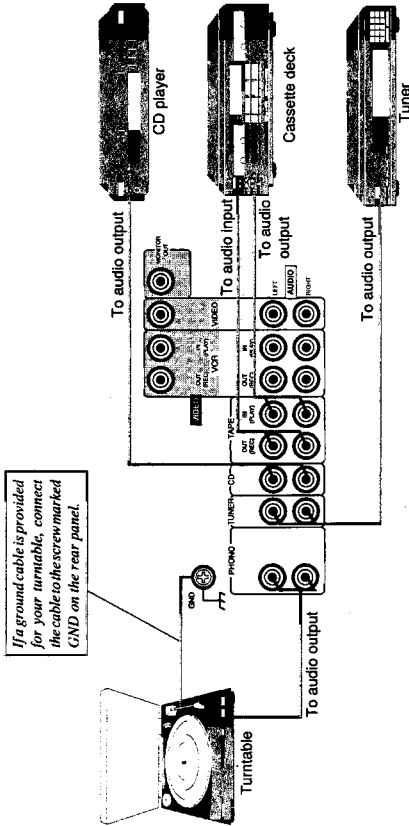

If a ground cable is provided for your turntable, connect the cable to the screw marked **GND** on the rear panel.

Connecting the Power Cord

Before plugging the amplifier into an AC outlet, make sure that all connections have been made.

1. Plug the power cord into an AC outlet.
2. Press **POWER** to set it in the **ON** position.
The **STANDBY** lamp lights up. A small amount of power is always consumed.



To shut off the power completely:
Press **POWER** to set it in the **OFF** position.

Keep the power cord away from the connecting cables for the TV, VCR, and antenna. The power cord may cause noise or screen interference.

The difference between the POWER switch and the STANDBY/ON button
The **POWER** switch is the mains supply switch, allowing the amplifier to connect to the mains supply. To shut off the power completely, press the **POWER** switch to set it in the **OFF** position.
The **STANDBY/ON** button is a functional on/off (standby) switch, and does not disconnect the amplifier from the mains supply. A small amount of power is consumed even in standby mode for the amplifier to accept signals from the remote control.

Notes:
The preset settings such as sound adjustment may be erased in the following cases:

- When you press **POWER** to set it in the **OFF** position.
- When you unplug the power cord.
- When a power failure occurs.

CAUTIONS:

- Do not touch the power cord with wet hands.
- Do not pull on the power cord to unplug the amplifier. When unplugging the amplifier, always grasp the plug itself so as not to damage the cord.

Putting Batteries in the Remote Control

Before using the remote control, put the two supplied batteries in first. When using the remote control, aim the remote control directly at the remote sensor on the amplifier.

1. On the back of the remote control, press down on the battery cover and slide it out.
2. Insert batteries. Make sure to observe the proper polarity: (+) to (+) and (-) to (-).
3. Slide the cover.

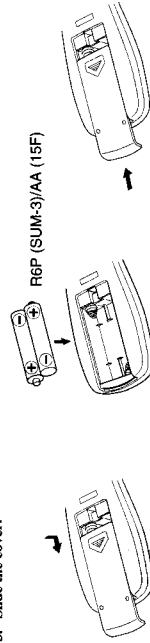

If the range or effectiveness of the remote control decreases, replace the batteries. Use two R6P (SUM-3)/AA (15F) type dry-cell batteries.

CAUTIONS:

- Follow these precautions to avoid leaking or cracking cells:
- Place batteries in the remote control so they match the polarity indicated: (+) to (+) and (-) to (-).
 - Use the correct type of batteries. Batteries that look similar may differ in voltage.
 - Always replace both batteries at the same time.
 - Do not expose batteries to heat or flame.

Video component connections

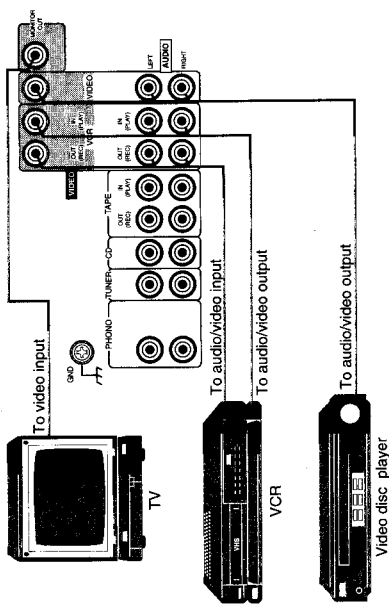

CAUTION:

If you connect a sound-increasing device such as a graphic equalizer between the source components and the amplifier, the sound output through the amplifier may be distorted.

Connecting Audio Components for the COMPU LINK-3 Remote Control System

The COMPU LINK-3 remote control system allows you to control other JVC audio components from the amplifier or vice versa. To use this system, connect your JVC audio components and the amplifier with the cable (monaural mini-plug) supplied with those components.

If your audio component has two COMPU LINK-3 SYNCHRO jacks, you can use either one. If it has only one COMPU LINK-3 SYNCHRO jack, connect it so that it is the last item in the series of components. (For example, the turntable and the tuner in the diagram below)

Notes:

- The COMPU LINK-3 remote control system is the upgraded version of the COMPU LINK-1 and COMPU LINK-2. Even if your component has the COMPU LINK-1 or COMPU LINK-2 jacks, you can still connect it in the COMPU LINK-3 remote control system, but some functions may not work correctly.
- For more information about the COMPU LINK-3 (-1 and -2) remote control system, see page 24.

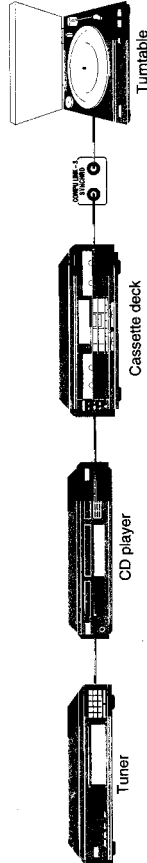

Basic Operations

The following operations are commonly used when you play any sound source.

Turning the Power On and Off (Standby)

On the front panel:

To turn on the power, press **STANDBY/ON** (⏻).
The **STANDBY** lamp goes off. The name of the current source appears on the display.

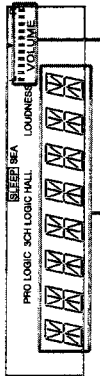

Current source name appears Current volume level is shown here

To turn off the power (into standby mode), press **STANDBY/ON** (⏻) again.
The **STANDBY** lamp lights up.



From the remote control:

To turn on the power, press **AUDIO**.

The **STANDBY** lamp goes off. The name of the current source appears on the display.

To turn off the power (into standby mode), press **AUDIO** again.
The **STANDBY** lamp lights up.

Note:

Pressing **STANDBY/ON** (⏻) again turns off the power (into standby mode) and lights the **STANDBY** lamp. A small amount of power is consumed in standby mode. To turn the power off completely, press **⓪ POWER** to set it in the **OFF** position on the front panel.

Selecting the Source to Play



On the front panel:

1. Press **SOURCE** so that **Control Δ / ▽** buttons work for selecting the source.
The lamp above the button lights up.
2. Press **Control Δ / ▽** until the source name you want appears on the display.

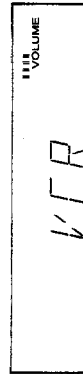
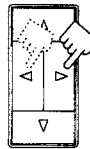

From the remote control:

Press one of the source button directly.

- CD* Listen to the CD player.
- TAPE* Listen to the cassette deck connected to the TAPE jacks.
- TUNER* Listen to the radio.
- VCR View the video component connected to the VCR jacks.
- VIDEO View the video component connected to the VIDEO jacks.
- PHONO* Listen to a record.

Note:

* When you press one of the source buttons on the remote control marked above with an asterisk, the amplifier automatically turns on.



Selecting different sources for picture and sound

You can watch picture from video equipment while listening to sound from audio equipment.
To listen to the sound from audio equipment while watching the picture from video equipment:

1. Select the video equipment as the source (**VIDEO** or **VCR**).
2. Press one of the source buttons for the audio equipment (**TUNER**, **TAPE**, **PHONO** or **CD**) on the remote control.

Selecting the Front Speakers

When you have connected two sets of front speakers, you can select which to use. Pressing **SPEAKERS 1** or **SPEAKERS 2** activates the respective set of speakers.



To use the set of speakers connected to the **FRONT SPEAKERS 1** terminals, press **SPEAKERS 1** to set it in the **ON** position, and press **SPEAKERS 2** to set it in the **OFF** position.

To use the set of speakers connected to the **FRONT SPEAKERS 2** terminals, press **SPEAKERS 2** to set it in the **ON** position, and press **SPEAKERS 1** to set it in the **OFF** position.

To use both sets of speakers, press both **SPEAKERS 1** and **2** to set them in the **ON** position.
To use neither set of speakers, press both **SPEAKERS 1** and **2** to set them in the **OFF** position.

Note:

When only one set of the front speakers is connected to either the **FRONT SPEAKERS 1** or **2** terminals, do not press both **SPEAKERS 1** and **2** to set them in the **ON** position. If you do, no sound comes out of the front speakers.

Adjusting the Volume

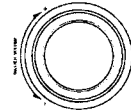

On the front panel:

To increase the volume, turn **MASTER VOLUME** clockwise.

To decrease the volume, turn it counterclockwise.

When you turn **MASTER VOLUME rapidly**, the volume level also changes rapidly.
When you turn **MASTER VOLUME slowly**, the volume level also changes slowly.

From the remote control:

To increase the volume, press **VOLUME +**.

To decrease the volume, press **VOLUME -**.

CAUTION:

Always set the volume to the minimum before starting any source. If the volume is set at its high level, the sudden blast of sound energy can permanently damage your hearing and/or ruin your speakers.

On the front panel



From the remote control

Muting the Sound

From the remote control only:

Press **MUTE** to mute the sound through all speakers and headphones connected.
"MUTE" appears on the display and the volume turns off.

To restore the sound, press **MUTE** again so that "OFF" appears on the display.

Turn **MASTER VOLUME** or pressing **VOLUME +/-** also restores the sound at the previous volume level.



Recording a Source

You can record any source playing through the amplifier to a cassette deck connected to the TAPE jacks and YCR connected to the YCR jacks at the same time. While recording, you can listen to the selected sound source at whatever sound level you like, without affecting the sound levels of the recording.

Note:
The output volume level, preset SEA, and surround modes cannot affect the recording.

Listening with Headphones

A standard pair of headphones can be connected to the PHONES jack on the front panel. Be sure to turn down the volume before connecting or putting on headphones, as high volume can damage both the headphones and your hearing.

To listen with only headphones
Press both SPEAKERS 1 and 2 to set them in the **OFF** position.



Basic Settings

Some of the following settings are required after connecting and positioning your speakers in your listening room, while others will make operations easier.

Adjusting the Front Speaker Output Balance

If the sounds you hear from the front right and left speakers are unequal, you can adjust the speaker output balance.

On the front panel only:

1. Press **SETTING** so that the Control $\Delta / \nabla / \triangleleft / \triangleright$ buttons work for adjusting the balance. The lamp above the button lights up.
2. Press Control Δ / ∇ until "BALANCE" appears on the display.
3. Press Control $\triangleleft / \triangleright$ to adjust the balance.
 - Pressing Control \triangleleft decreases the right channel output.
 - Pressing Control \triangleright decreases the left channel output.

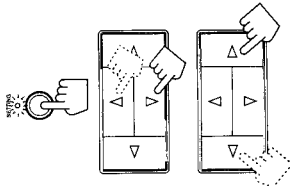

Listening at Low Volume (Loudness)

Human ears are not sensitive to bass at low volume. To compensate for this, the loudness function automatically boosts the bass level as you lower the volume.

On the front panel only:

1. Press **SETTING** so that the Control $\Delta / \nabla / \triangleleft / \triangleright$ buttons work for setting the loudness. The lamp above the button lights up.
2. Press Control Δ / ∇ until "LOUDNESS" appears on the display.
3. Press Control $\triangleleft / \triangleright$ to set the loudness function to "ON" or "OFF."
 - Select "ON" to activate the loudness function. The LOUDNESS indicator lights up on the display.
 - Select "OFF" to cancel it. The indicator goes off.

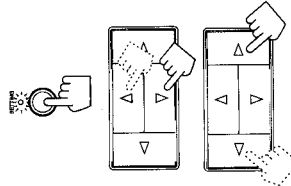

Using the Sleep Timer

Using the Sleep Timer, you can fall asleep to music and know the amplifier will turn off by itself rather than play all night.

On the front panel only:

1. Press **SETTING** so that the Control $\Delta / \nabla / \triangleleft / \triangleright$ buttons work for setting the Sleep Timer. The lamp above the button lights up.
2. Press Control Δ / ∇ until "<SLEEP>" appears on the display.
3. Press Control $\triangleleft / \triangleright$ to set the shut-off time. Each time you press the button, the shut-off time on the display changes as follows, and the SLEEP indicator lights up on the display.

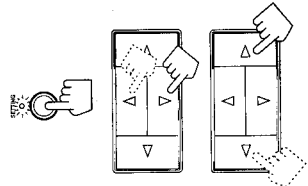

Continue to the next page

One Touch Operation

This amplifier can memorize the optimum sound setting for each playing source.

About the One Touch Operation

JVC's One Touch Operation function is used to assign and store different sound settings for each different playing source. By using this function, you do not have to change the settings every time you change the source. The stored settings for the newly selected source are automatically recalled.

The following can be stored for each source:

- Volume level (see page 10)
- Balance (see page 12)
- Loudness (see page 12)
- Preset SEA modes (see page 15)
- Surround mode settings (see page 17)

Using the One Touch Operation

To store the sound settings:

1. Press **ONE TOUCH OPERATION**.
The **ONE TOUCH OPERATION** lamp lights up, then the previously memorized settings are recalled and appear on the display in turn.
2. Adjust the sound using the functions listed above.
The newly adjusted settings are memorized.

To recall the sound settings:

With the **ONE TOUCH OPERATION** lamp lit, the settings for the currently selected source is recalled, and appears on the display when the source is selected.

To cancel the One Touch Operation function:

Press **ONE TOUCH OPERATION** so that the lamp goes off. (Even though the One Touch Operation function is canceled, the recalled sound effects remain active.)

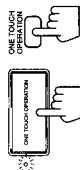

On the front panel
From the remote control

When the shut-off time comes, the amplifier turns off (into standby mode) automatically.

To check or change the time remaining until the shut-off time:

1. Press **SETTING** if necessary, so that the Control $\Delta / \nabla / \triangleleft / \triangleright$ buttons work for setting the Sleep Timer.
2. Press Control Δ / ∇ if necessary, until "<SLEEP>" appears on the display.
3. Press Control $\triangleleft / \triangleright$.

The remaining time until the shut-off time appears in minutes.

• To change the shut-off time, press Control $\triangleleft / \triangleright$ repeatedly.

To cancel the Sleep Timer, press Control $\triangleleft / \triangleright$ repeatedly in step 3 above until "0" appears on the display.

(The SLEEP indicator goes off.)

Turning off the power (into standby mode) also cancels the Sleep Timer.

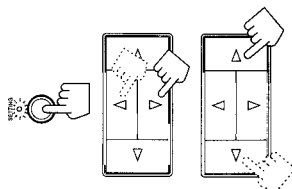

Selecting the Center Speaker Size

You can register the information about the center speaker after all connections are completed.

If you do this registration first, you do not have to adjust the center speaker mode when you want to activate the surround sound.

However, to register the information, first you have to set the surround mode either to "PROLOGIC" or "3CHLOGIC." (You cannot select the center speaker size when the surround mode is "OFF" or "HALL.")

On the front panel only:

1. Press **SURROUND** so that the Control Δ / ∇ buttons work for selecting the surround mode.
The lamp above the button lights up.
2. Press Control Δ / ∇ until "PROLOGIC" or "3CHLOGIC" appears on the display.
The indicator of the selected mode also lights up on the display.
3. Press **SETTING** so that the Control $\Delta / \nabla / \triangleleft / \triangleright$ buttons work for selecting the center speaker size.
The lamp above the button lights up.
4. Press Control Δ / ∇ until "CNTR SPK" (Center Speaker) appears on the display.
5. Press Control $\triangleleft / \triangleright$ to select the appropriate item about your center speaker.
Each time you press the button, the display changes to show the following:



LARGE	Select this mode when the size of the center speaker is the same as that of the front speakers.
SMALL	Select this mode when the size of the center speaker is smaller than that of the front speakers.
NO	Select this mode when you do not use a center speaker. (This mode cannot be selected when you select "3CHLOGIC.")

Note:

This "center speaker size" setting is so related to the center mode setting for the Dolby Surround that changing this setting affects and changes the center mode to a relevant mode, and vice versa.
For example,

- If you select "LARGE," the center mode is automatically set to "WIDE," and vice versa.
- If you select "SMALL," the center mode is automatically set to "NORMAL," and vice versa.
- If you select "NO," the center mode is automatically set to "PHANTOM" for PROLOGIC, and vice versa.

Using the Preset SEA Modes

The preset SEA (Sound Effect Amplifier) modes give you control over the way your music sounds.

Note:
The preset SEA mode cannot be used for recording.

Selecting Your Favorite SEA Mode

On the front panel:

1. Press **PRESET SEA** so that the Control Δ / ∇ / \triangleleft / \triangleright buttons work for preset SEA setting. The lamp above the button lights up.
2. Press Control Δ / ∇ until the mode you want appears on the display. The SEA indicator also lights up on the display. Each time you press the button, the preset SEA modes change as follows:

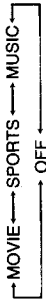

Note:
When you turn on the preset SEA mode, the mode and its effect level previously selected is recalled at first.

3. Press Control \triangleleft / \triangleright to select the effect level. Each time you press the button, the effect level changes as follows:

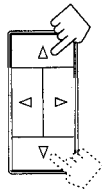
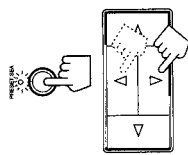
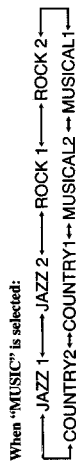

MOVIE	Adds breadth to sounds so you feel like you are in a movie theater.
SPORTS	Makes sound exciting.
MUSIC	Select one of the modes below: JAZZ: Gives a feeling of a live atmosphere. Good for acoustic music. ROCK: Gives a heavy sound. Both high and low frequencies are boosted. MUSICAL: Enhances the mid-frequency range, which the human voice is mostly made up of. COUNTRY: Enhance the high-frequency range so that instruments such the violin and banjo are emphasized.
OFF	No preset SEA mode is applied. (See below)

To cancel the preset SEA mode, select "OFF" in step 2 above. The SEA indicator goes off from the display.

From the remote control:

1. Press **SEA ON/OFF** so that the SEA indicator lights up on the display. The previously selected mode is recalled (at its previous effect level) and is shown on the display. Each time you press the button, the preset SEA mode turns on and off.

Note:
When selecting the preset SEA mode, the display will show the current effect level of the preset SEA mode selected.

2. Press **AUDIO CONTROL** so that 10 keys work for adjusting the sound.

3. Press **SEA MODE** until the mode you want appears on the display. Each time you press the button, the three preset SEA modes change as follows:

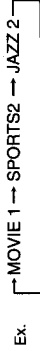

4. Press **PRESET** to select the effect level. Each time you press the button, the effect level changes as follows:

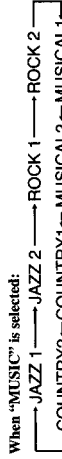

To cancel the preset SEA mode, press **SEA ON/OFF** so that the SEA indicator goes off from the display. Each time you press the button, the preset SEA mode turns on and off.

Using the Surround Processor

The built-in surround processor provides three types of surround programs — Dolby Pro Logic, Dolby 3-Channel Logic, and JVC's Hall Surround.

What is surround?

The sound heard in a concert hall or a movie theater consists of direct sound and indirect sound: early reflections and reflections from behind. The reflected sounds are always delayed by the distances of the ceiling and walls from the listener. These reflections are some of the most important elements of the acoustic surround.

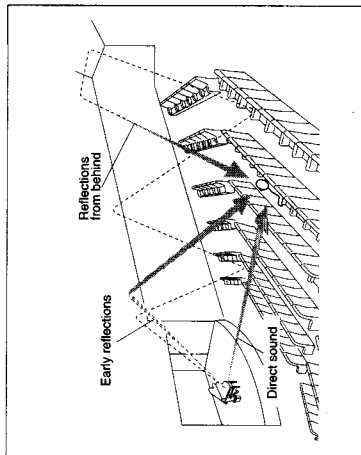

On JVC's Hall Surround

In order to reproduce a more realistic sound field in your listening room while playing an ordinary stereo source, JVC's Hall Surround has been designed to give you clear vocals and to create the feeling of a concert hall. The sound is reproduced through the front speakers and rear speakers.

On Dolby Surround

Dolby Surround has been also developed to reproduce the important elements of the acoustic surround at home.

To watch the soundtracks of video software bearing the mark  which includes the same encoded surround information as found in Dolby Stereo films, the amplifier can provide you with 2 Dolby Surround programs (Dolby Pro Logic and Dolby 3ch Logic).

Dolby Pro Logic: Select this mode when the optional rear speakers are connected (as well as a center speaker).

Dolby 3ch Logic: Select this mode when a center speaker is connected without rear speakers.

Notes:

- The surround processor has no effect on monaural sources.
- The surround processor cannot be used for recording.

Using JVC's Hall Surround

You need to connect one set of rear speakers to obtain the full effect. Once you have adjusted the Hall Surround, the amplifier memorizes the settings.

On the front panel:

1. Press SURROUND so that the Control $\Delta / \nabla / \triangleleft / \triangleright$ buttons work for selecting the surround modes.

The lamp above the button lights up.



2. Press Control Δ / ∇ until "HALL" appears on the display.

The HALL indicator also lights up on the display. Each time you press the button, the surround modes change as follows:

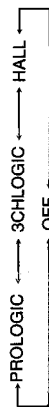

The indicator of the selected surround mode lights up in turn as you select the surround modes.

3. Press ADJUST so that the Control $\Delta / \nabla / \triangleleft / \triangleright$ buttons work for surround settings. The lamp above the button lights up.

4. Press Control Δ / ∇ until "REAR +" appears on the display.

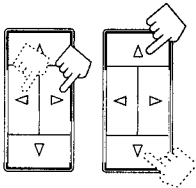

5. Press Control $\triangleleft / \triangleright$ to adjust the rear speaker output level.

- Pressing Control \triangleleft decreases the output level up to -10 dB.
- Pressing Control \triangleright increases the output level up to +10 dB.

6. Press Control Δ / ∇ until "DELAY +" appears on the display.

7. Press Control $\triangleleft / \triangleright$ to adjust the delay time of the rear speaker output.

Each time you press the button, the delay time changes as follows:



DELAY 1	Select this when the distance from you to your rear speakers is greater than that to the front speakers.
DELAY 2	Select this when the distance from you to your rear speakers is almost equal to that to the front speakers.
DELAY 3	Select this when the distance from you to your rear speakers is less than that to the front speakers.

To cancel the Hall surround, select "OFF" in step 2. The HALL indicator goes off.

From the remote control:

1. Press SURROUND ON/OFF so that one of the surround mode indicators (PRO LOGIC, 3CH LOGIC, HALL) lights up on the display.

The previous mode is recalled (at its previous settings) and is shown on the display. Each time you press the button, the surround mode turns on and off.

2. Press AUDIO CONTROL so that 10 keys work for adjusting the sound.

3. Press SURR MODE until "HALL" appears on the display.

The HALL indicator also lights up on the display.

Each time you press the button, the surround modes change as follows:



The indicator of the selected surround mode lights up in turn as you select the surround modes.

4. Press REAR +/- to adjust the rear speaker output level.

- Pressing REAR - decreases the output level up to -10 dB.
- Pressing REAR + increases the output level up to +10 dB.

5. Press DELAY to adjust the delay time.

Each time you press the button, the delay time changes as follows:

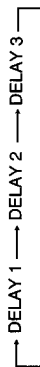

To cancel the Hall Surround, press SURROUND ON/OFF so that the HALL indicator goes off. Each time you press the button, the surround mode turns on and off.

From the remote control:
If you have already set the center speaker size following the procedure described on page 13, you can use the remote control for Dolby Surround preparation.

1. Press SURROUND ON/OFF so that one of the surround mode indicators (PRO LOGIC, 3CH LOGIC, HALL) lights up on the display.
The previous mode is recalled (at its previous settings) and is shown on the display.
Each time you press the button, the surround mode turns on and off.
2. Press AUDIO CONTROL so that 10 keys work for adjusting the sound.
3. Press SURR MODE until "PROLOGIC" or "3CHLOGIC" whichever you want appears on the display.
Each time you press the button, the surround modes change as follows:
→ PROLOGIC → 3CHLOGIC → HALL

The indicator of the selected surround mode lights up in turn as you select the surround modes.

4. Press DELAY to adjust the delay time of the rear speaker output.
Each time you press the button, the delay time changes as follows:
→ DELAY 1 → DELAY 2 → DELAY 3

Note:
When you have selected "3CHLOGIC," you cannot adjust the delay time.

5. Press TEST to start checking the speaker output balance.
"TEST" starts flashing on the display, and a test tone comes out of the speakers in the following order:

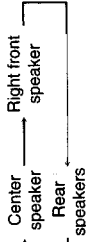

- Notes:
- No test tone comes out of the rear speakers when you have selected "3CHLOGIC."
 - No test tone comes out of the center speaker when you select "PHANTOM" or "OFF" for the center mode.

6. If necessary, adjust the speaker output balance as follows:
• To adjust the rear speaker output level, press REAR+/-.
• To adjust the center speaker output level, press CENTER +/-.

Pressing - decreases the output level up to -10 dB.
Pressing + increases the output level up to +10 dB.

- Notes:
- The sound levels of the left and right rear speakers will be the same.
 - You cannot set the sound level of the rear speakers when you have selected "3CHLOGIC."
 - You cannot set the sound level of the center speaker when you select "PHANTOM" or "OFF" for the center mode.

7. Press TEST again to stop the test tone.



6. Press Control Δ/∇ until "-DELAY +" appears on the display.

Press Control $\triangleleft/\triangleright$ to adjust the delay time of the rear speaker output.
Each time you press the button, the delay time changes as follows:



DELAY 1	Select this when the distance from you to your rear speakers is greater than that to the front speakers.
DELAY 2	Select this when the distance from you to your rear speakers is almost equal to that to the front speakers.
DELAY 3	Select this when the distance from you to your rear speakers is less than that to the front speakers.

Note:
When you have selected "3CHLOGIC," you cannot adjust the delay time.

8. Press Control Δ/∇ until "TEST" appears on the display, then press Control $\triangleleft/\triangleright$ to start checking the speaker output balance.
"TEST" starts flashing on the display, and a test tone comes out of the speakers in the following order:

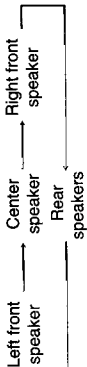

- Notes:
- No test tone comes out of the rear speakers when you have selected "3CHLOGIC."
 - No test tone comes out of the center speaker when you select "PHANTOM" or "OFF" for the center mode.

9. If necessary, adjust the speaker output balance as follows:

- To adjust the rear speaker output level, press Control Δ/∇ until "- REAR +" appears on the display, then press Control $\triangleleft/\triangleright$.
- To adjust the center speaker output level, press Control Δ/∇ until "- CENTER+" appears on the display, then press Control $\triangleleft/\triangleright$.

- Notes:
- The sound levels of the left and right rear speakers will be the same.
 - You cannot set the sound level of the rear speakers when you have selected "3CHLOGIC."
 - You cannot set the sound level of the center speaker when you select "PHANTOM" or "OFF" for the center mode.

10. Press Control Δ/∇ until "TEST" appears on the display, then press Control $\triangleleft/\triangleright$ to stop the test tone.

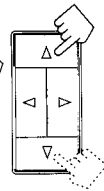
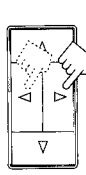
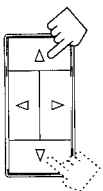
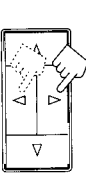

Speaker Arrangements for Dolby Surround

The following illustrations show how to obtain the optimum sound environment for various Dolby Surround settings. Try to find the speaker direction and location to create the optimum sound field.

CASE 1 When you have added a center speaker and rear speakers

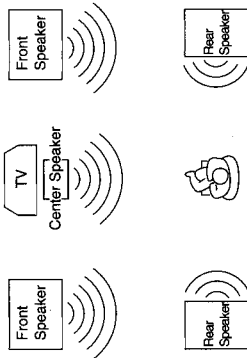

- In this case:**
1. Select "PROLOGIC."
 2. Select "NORMAL" or "WIDE" for center mode.
- See pages 20 to 22 for more details.

CASE 2 When you have added rear speakers (without a center speaker)

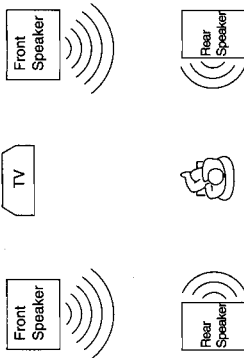

- In this case:**
1. Select "PROLOGIC."
 2. Select "PHANTOM" for center mode.
- See pages 20 to 22 for more details.

CASE 3 When you have added a center speaker (without rear speakers)

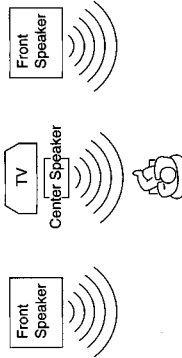

- In this case:**
1. Select "3CHLOGIC."
 2. Select "NORMAL" or "WIDE" for center mode.
- See pages 20 to 22 for more details.

Preparing for Dolby Surround

The amplifier memorizes two sets of Dolby Surround adjustments, one for Pro Logic and the other for 3ch Logic.

- On the front panel:**
1. Press SURROUND so that the Control Δ / ∇ buttons work for selecting the surround modes. The lamp above the button lights up.

2. Press Control Δ / ∇ until "PROLOGIC" or "3CHLOGIC" whichever you want appears on the display.

The PRO LOGIC or 3CH LOGIC indicator also lights up. Each time you press the button, the surround modes change as follows:

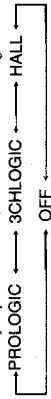

The indicator of the selected surround mode lights up in turn as you select the surround modes.

PROLOGIC	Select this mode when you use a center speaker and rear speakers.
3CHLOGIC	Select this mode when you use a center speaker without rear speakers. This is JVC's original surround mode, and is different from Dolby Surround. To use this, see page 17.
HALL	Select this to turn off the surround mode.
OFF	

3. Press ADJUST so that the Control Δ / ∇ / \triangleleft / \triangleright buttons work for adjusting the selected surround mode. The lamp above the button lights up.

4. Press Control \triangleleft / \triangleright to select the center mode. (Center Mode) appears on the display.

5. Press Control \triangleleft / \triangleright to select the center mode. Each time you press the button, the center modes change as follows:

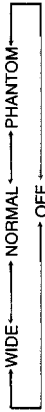

WIDE	Select this mode when the center speaker can reproduce the bass better than the front speakers. All signals of the center channel are output through the center speaker.
NORMAL	Select this mode when the center speaker cannot reproduce the bass better than the front speakers. The bass portions of the center channel signals are output through the front speakers.
PHANTOM	Select this mode when you do not use a center speaker. The center speaker channel signals are output through the front speakers.
OFF	Select this mode to turn off the center speaker channel.

Notes:

- If you have already set the center speaker size following the procedure described on page 13, you do not have to select the center mode in this procedure.
- When you have selected "3CHLOGIC," you cannot select "PHANTOM."

Continue to the next page

Once you have set the Dolby Surround adjustments, you can use the same adjustments every time you want to enjoy Dolby Surround.

On the front panel:

1. Press **SURROUND** so that the Control Δ/∇ buttons work for selecting the surround modes. The lamp above the button lights up.

2. Press Control Δ/∇ until "PROLOGIC" or "3CHLOGIC" whichever you want appears on the display. The PRO LOGIC or 3CH LOGIC indicator also lights up.

Each time you press the button, the surround modes change as follows:

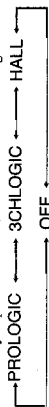

The indicator of the selected surround mode lights up in turn as you select the surround modes.

3. Select and play a sound source which was processed with Dolby Surround and is labeled with  mark.

To cancel Dolby Surround, select "OFF" in step 2 above. The indicator of the selected mode goes off.

From the remote control:

1. Press **SURROUND ON/OFF** so that one of the surround mode indicators (PRO LOGIC, 3CH LOGIC, HALL) lights up on the display.

The previous mode is recalled (at its previous settings) and is shown on the display. Each time you press the button, the surround mode turns on and off.

2. Press **AUDIO CONTROL** so that 10 keys work for adjusting the sound.

3. If necessary, press **SURR MODE** until "PROLOGIC" or "3CHLOGIC" whichever you want appears on the display.

Each time you press the button, the surround modes change as follows:



The indicator of the selected surround mode lights up in turn as you select the surround modes.

4. Select and play a sound source which was processed with Dolby Surround and is labeled with  mark.

To cancel Dolby Surround, press **SURROUND ON/OFF** so that the indicator of the selected mode goes off. Each time you press the button, the surround mode turns on and off.

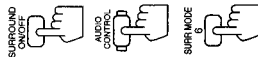
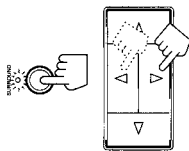

COMPU LINK Remote Control System

The COMPU LINK remote control system allows you to operate JVC audio components through the remote sensor on the amplifier.

To use this remote control system, you need to connect JVC audio components through the COMPU LINK-3 SYNCHRO jacks with the cables (monaural mini-plug supplied with those components). For details, see page 7.

Notes:

- Without connecting the audio components with RCA pin plugs as described on page 6, the COMPU LINK remote control system cannot operate the components.
- Refer also to the manuals supplied with your audio components.

This remote control system allows you to use the four functions listed below.

Remote Control through the Remote Sensor on the Amplifier

You can control JVC audio components through the remote sensor on the amplifier using this remote control. Aim the remote control directly at the remote sensor on the amplifier. For details, see page 25.

Automatic Source Selection

When you start playing on a connected component, the amplifier automatically turns on and changes its source to the component. On the other hand, if you select a new source on the amplifier or the remote control, the selected component begins playing immediately.

In both cases, the previously selected source continues playing without sound for a few seconds.

Automatic Power On/Off (Standby) (only possible with the COMPU LINK-3 connection)

The audio components (tuner, CD player and cassette deck) connected to the amplifier automatically turn on and off (into standby mode) with the amplifier.

When you turn on the amplifier, one of the connected components will turn on automatically, depending which component has been previously selected.

When you turn off the amplifier (into standby mode), these components connected will turn off (into standby mode).

Synchronized Recording

Synchronized recording means the cassette deck starts recording as soon as a CD or record begins playing.

To use synchronized recording, follow these steps:

1. Put a tape in the cassette deck, and a disc in the CD player (or a record on the turntable).
2. Press the record (●) button and the pause (II) button on the cassette deck at the same time.

This puts the cassette deck into recording pause.

Note:

If you do not press the record (●) button and pause (II) button at the same time, the synchronized recording feature will not operate.

3. Press the play (▶) button on the CD player or on the turntable.

The source changes on the amplifier, and as soon as play starts, the cassette deck starts recording. When the play ends, the cassette deck enters recording pause, and stops 4 seconds later.

Notes:

- During synchronized recording, the selected source cannot be changed.
- If your CD player is playing in program mode, a 4-second blank is recorded between tracks so that the music scan feature of your cassette deck can be used on the recorded tape.
- If the power of any component is shut off during synchronized recording, the COMPU LINK remote control system may not operate properly. In this case, you must start again from the beginning.
- Refer also to the manuals supplied with your CD player and cassette deck.

Using the Remote Control

You can operate JVC audio and video components with the amplifier's remote control, since control signals for JVC components are preset in the remote control.
To operate these components with the remote control, first select a source with the source buttons on the remote control. Then, operate that source using the remote control.

IMPORTANT:

- To operate JVC audio components using this remote control:
 - You need to connect JVC audio components through the COMPU LINK-3 SYNCHRO jacks (see page 7) in addition to the connectors using cables with RCA pin plugs (see page 6).
 - Aim the remote control directly at the remote sensor on the amplifier.

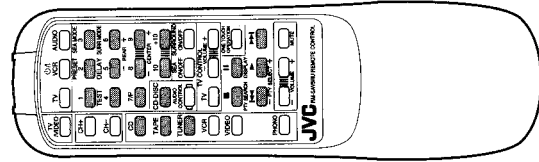

After pressing TUNER, you can perform the following operations:
 1 — 10, +10 Selects a preset channel number directly
 For channel number 5, press 5.
 For channel number 15, press +10, then 5.
 For channel number 20, press +10, then 10.
 For channel number 30, press +10, +10 then 10.

RDS operating buttons
 PTY SEARCH Starts and ends searching a broadcast using the RDS.
 PTY SELECT +/- Selects a program type.
 DISPLAY Changes the RDS display mode.

After pressing CD, you can perform the following operations on a CD player:

- Starts playing
- Returns to the beginning of the current (or previous) track
- Skips to the beginning of the next track
- Stops playing
- Pauses. To resume playing, press ►
- Selects a track number directly
- For track number 5, press 5.
- For track number 15, press +10, then 5.
- For track number 20, press +10, then 10.
- For track number 30, press +10, +10, then 10

After pressing CD-DISC, you can perform the following operations on a CD player-changer:

- 1 — 6, 7/P Select the number of a disc installed in a CD player-changer. Then continue to operate the CD player as described above.

After pressing TAPE, you can perform the following operations on a cassette deck:

- Starts playback
- Fast winds a tape from right to left
- Fast winds a tape from left to right
- Stops operation
- Pauses. To resume playing, press ►

IMPORTANT:

To operate JVC video components using this remote control:
 • Aim the remote control directly at the remote sensor on the VCR or TV, not on the amplifier.

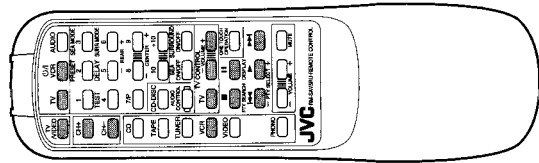

After pressing VCR, you can perform the following operations on a VCR:

- Starts playback
 - Re-winds a video tape
 - Fast winds a video tape
 - Stops operation
 - Pauses. To resume playing, press ►
 - Changes channels on a VCR
- Without pressing VCR, you can always perform the following:
 VCR (in the ◁/▷ (Standby/On) section)
 Turns on/off the VCR

After pressing TV (in the TV CONTROL section), you can perform the following operations on TV:

- CH+/- Changes TV channels
- Without pressing TV (in the TV CONTROL section), you can always perform the following :
 TV/VIDEO Sets input mode (either to TV or to VIDEO)
 VOLUME +/- (in the TV CONTROL section)
 Adjusts the volume
 TV (in the ◁/▷ (Standby/On) section)
 Turns on/off the TV

Use this chart to help you solve daily operational problems. If there is any problem you cannot solve, contact your JVC service center.

PROBLEM	POSSIBLE CAUSE	SOLUTION
The display does not light up	The power cord is not plugged in or the POWER switch is pressed to set in the OFF position	Plug the power cord into an AC outlet and press POWER to set it in the ON position
No sound from speakers	Speaker signal cables are not connected	Check speaker wiring and reconnect if necessary
	The SPEAKERS 1 and 2 are not set correctly	Press SPEAKERS 1 and 2 correctly
	An incorrect source is selected	Select the correct source
Sound from one speaker only	Speaker signal cables are not connected properly	Check speaker wiring and reconnect if necessary
	The balance is set to one extreme	Adjust the balance properly (see page 12)
Howling during record playing	Your turntable is too close to speakers	Move speakers away from the turntable
Remote control does not work	There is an obstruction in front of the remote sensor on the amplifier	Remove the obstruction
	Batteries are weak	Replace batteries

Specifications

Amplifier

Output Power	At Stereo Operation Front Channels	At Surround Operation Front Channels	Center Channel	Rear Channels
	50 watts per channel, min. RMS, driven into 4 ohms at 1 kHz with no more than 0.9% total harmonic distortion. (IEC268-3/DIN)	30 watts per channel, min. RMS, driven into 8 ohms at 1 kHz with no more than 0.9% total harmonic distortion. (IEC268-3/DIN)	30 watts per channel, min. RMS, driven into 8 ohms, 40 Hz to 20 kHz with no more than 0.8% total harmonic distortion.	40 watts per channel, min. RMS, driven into 8 ohms at 1 kHz with no more than 0.8% total harmonic distortion.
			40 watts, min. RMS, driven into 8 ohms at 1 kHz, with no more than 0.8% total harmonic distortion.	40 watts per channel, min. RMS, driven into 8 ohms at 1 kHz, with no more than 0.8% total harmonic distortion.
Total Harmonic Distortion (8 ohms, 1 kHz)	0.8%* at 30 watts output (* Measured by JVC Audio Analysis System)			
Frequency Response (8 ohms)	20 Hz to 20 kHz (±1 dB) 20 Hz to 20 kHz (±1 dB)			
Audio Input Sensitivity/Impedance (1 kHz)	2.5 mV/47 k ohms 200 mV/47 k ohms			
Audio Output Level	200 mV			
Signal-to-Noise Ratio (66 IHF/DIN)	70 dB/66 dB 87 dB/67 dB			
RIAA Phono Equalization	±0.5 dB (20 Hz to 20 kHz) +5 ± 2 dB at 100 Hz			
Loudness (Volume Control at -40 dB)	1 Vp-p/75 ohms			
Video Input Sensitivity/Impedance	1 Vp-p (at 1 Vp-p input)			
Video Output Level	negative			
Synchronization	45 dB			
Signal-to-Noise Ratio				

General

Power Requirements	AC 230V [~] , 50 Hz
Power Consumption	240 watts 5 watts (in standby mode)
Dimensions (W x H x D)	435 x 146 x 403 mm (17 1/8 x 5 3/4 x 15 7/8 inches)
Mass	8.0 kg (17.7 lbs)

Design & specifications are subject to change without notice

AX-V5BK

-MEMO-

Description of Major LSIs

■ MN173222JAAM2 (IC401) : System Controller

1. Terminal Layout

	40 ~ 64	
1		63
}		}
21		43
	22 ~ 42	

2. Key Matrix

	KEY IN 0 (PIN7)	KEY IN 1 (PIN8)	KEY IN 2 (PIN9)	KEY IN 3 (PIN10)
KEY OUT 0 (PIN15)	POWER (S401)	--	--	--
KEY OUT 1 (PIN16)	SURROUND (S402)	PRESET SEA (S403)	--	SETTING (S405)
KEY OUT 2 (PIN17)	SOURCE (S406)	ADJUST (S407)	ONE TOUCH OPERATION (S408)	--
KEY OUT 3 (PIN18)	← (S410)	→ (S411)	↑ (S412)	↓ (S413)

3. Description

Pin No.	Symbol	I/O	Function	Pin No.	Symbol	I/O	Function
1,2	IN1,IN2	I	JOG VOL. control	53	CK	O	Clock signal to IC121
3	VIDEO1	O	Video select signal	54	DI	I	Data signal for IC121
4	VIDEO2	O	Video select signal	55	DO	O	Data signal to IC121
5	STD.1	O	STAND-BY indication control	56	DCSI	I	COMPULINK signal input
6	STB 3	O	Load strobe signal to IC202	57	DCSO	O	COMPULINK signal output
7~10	KI0~KI3	I	Key matrix in	58	STB2	O	Load strobe signal to IC201
11	VCR S/C	I	VCR S/C select signal	59	POWER	O	POWER ON/OFF control
12~14	G11~G9	O	Grid control signal	60	SURR	O	SURROUND ON/OFF control
15	G8/KO0	O	Grid control signal (Key matrix out)	61	STB5	O	Load strobe signal to IC641
16	G7/KO1	O	Grid control signal (Key matrix out)	62	T.MUTE	O	Tuner mute signal output
17	G6/KO2	O	Grid control signal (Key matrix out)	63	S.MUTE	O	SORCE muteing control
18	G5/KO3	O	Grid control signal (Key matrix out)	64	TV.CONT.	--	Pull down
19	G4	O	Grid control signal	65	TV OUT	--	Pull down
20	G3/KO5	O	Grid control signal (Key matrix out)	66	VCR OUT	--	Pull down
21	G2/KO6	O	Grid control signal (Key matrix out)	67	VCR IN	--	Pull down
22	G1/KO7	O	Grid control signal (Key matrix out)	68	RESTE IN	I	Reset signal input
23	V _{pp}	--	Power supply for FL display	69	X1	--	Connect to GND
24~39	S1~S16	O	Segment control signal	70	X2	--	Not used
40	STB1	O	Load strobe signal to IC321	71	V _{SS}	--	Connect to GND
41	CLK	O	Clock signal to IC201,202,252,321,601,641	72	OSC2	--	Oscillation terminal
42	STB4	O	Load strobe signal to IC252	73	OSC1	--	Oscillation terminal
43	DATA	O	Data signal to IC201,202,252,321,601,641	74	VDD	--	Power supply
44	INH	I	Inhibit signal input	75	SET.I	O	SETTING indication control
45	RDS CLK	O	Clock signal to IC191	76	ADJ.I	O	ADJUST indication control
46	RDS DATA	I	Data signal for IC191	77	SURR.I	O	SURROUND indication control
47	RDS RESET	O	Reset signal to IC191	78	SOURCE.I	O	SORCE indication control
48	RM	I	Remocon signal for IC402	79	SEA.I	O	SEA indication control
49	D-START	I	Data start signal for IC191	80	BAND.I	O	TUNER BAND indication control
50	STEREO	I	STEREO signal input	81	MUSIC.I	--	Pull up
51	TUNED	I	Tunig signal input	82	SPORTS.I	--	Pull up
52	CE	O	chip enable to IC121	83	MOVIE.I	--	Pull up
				84	ONE/I	O	ONE TOUCH OP. indication control

AX-V5BK

■ GP1U501X (IC402) : Receiver for remote controller

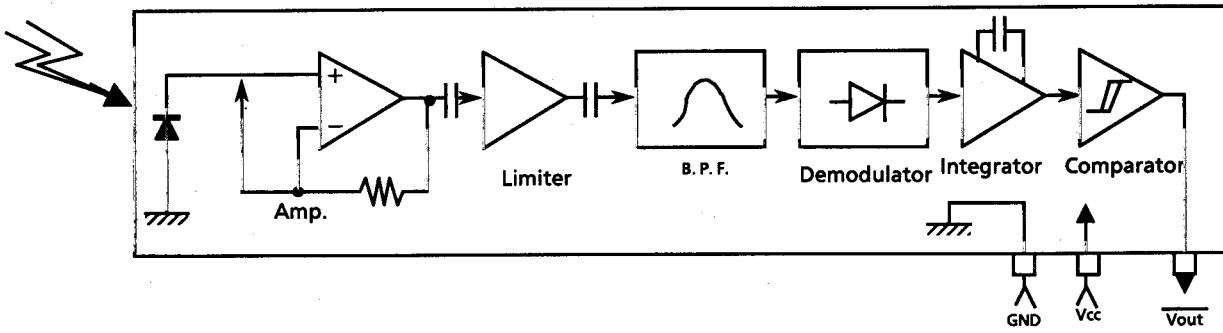

■ PST600E (IC403) : Reset IC

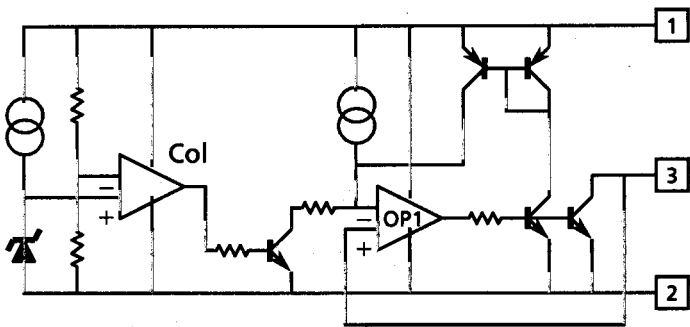

■ TA7317P (IC901) : PROTECTOR IC

(1) Terminal Layout

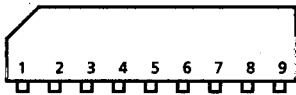

(2) Block Diagram

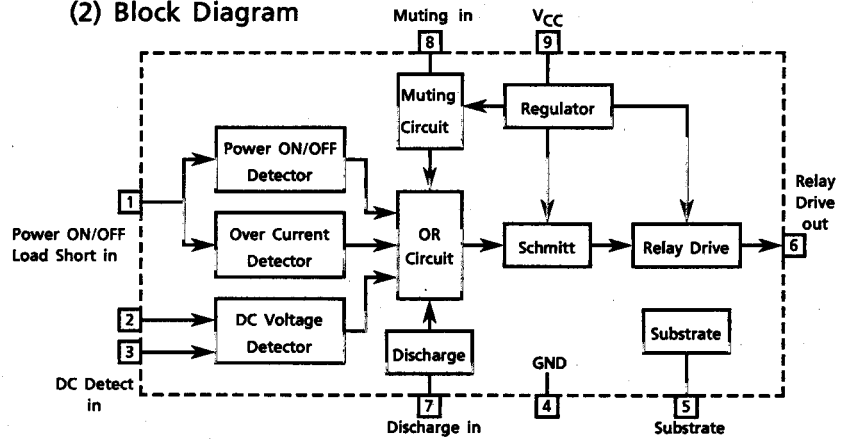

■ NJM2246D (IC671) : Video Switch

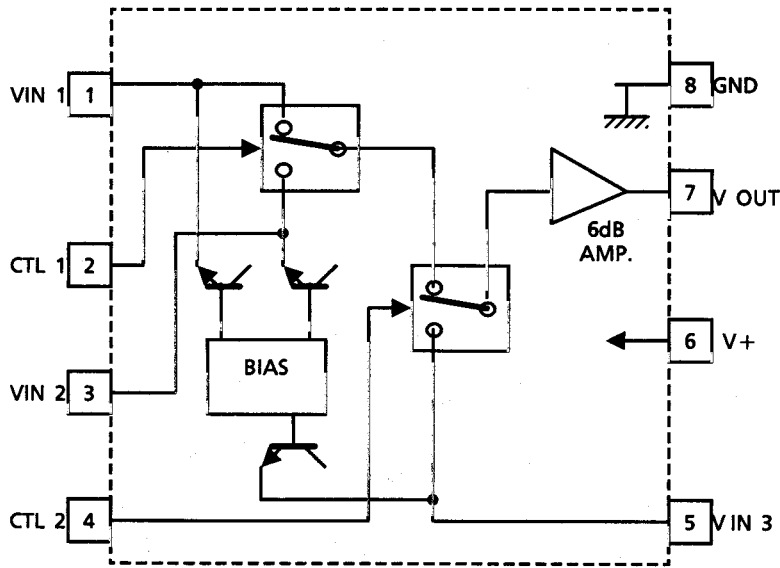

Control Signal—OutputSignal

CTL 1	CTL 2	Output
L	L	VIN 1
H	L	VIN 2
L/H	H	VIN 3

■ M5243P (IC551) : S.E.A. Graphic Equalizer

1. Functions
It makes inductive characteristic instead of coil.
2. Block Diagram

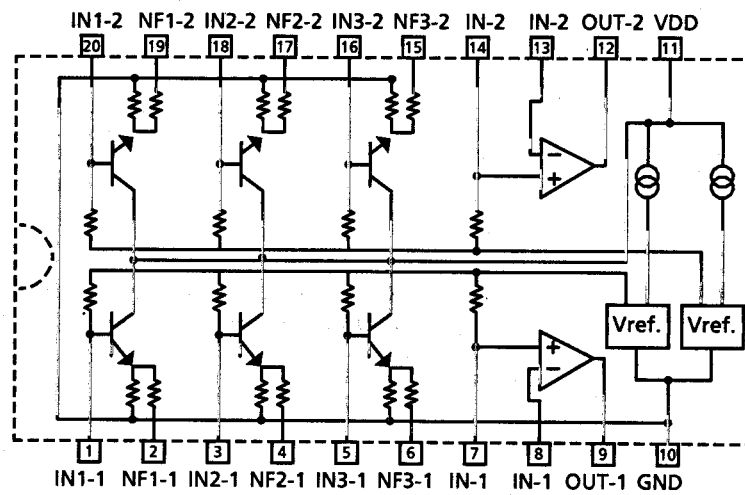

AX-V5BK

■TC9163AN(IC252) , TC9164AN(IC321) : Analog Switch

1. Functions

These analog switches are controlled by 14-bit serial data from computer for selecting the source.

2. Terminal Layout & Block diagram

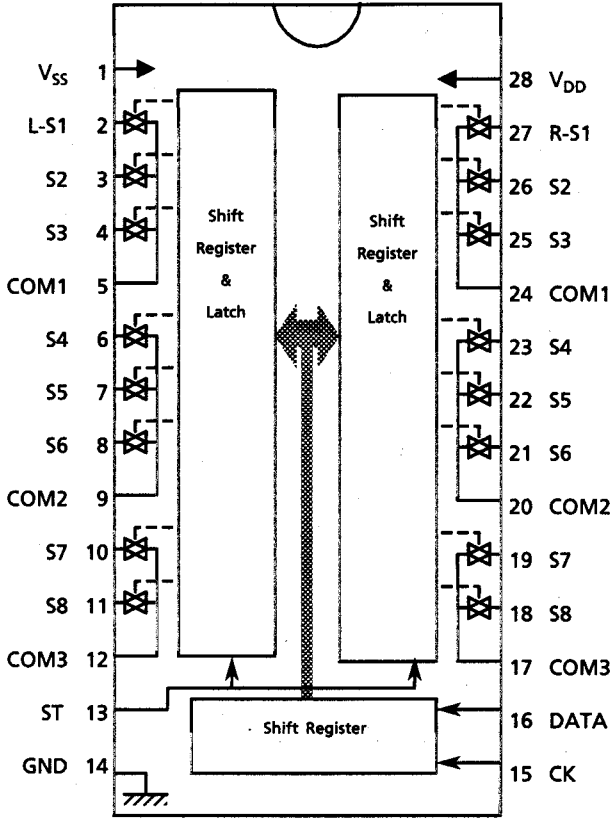

TC9163AN

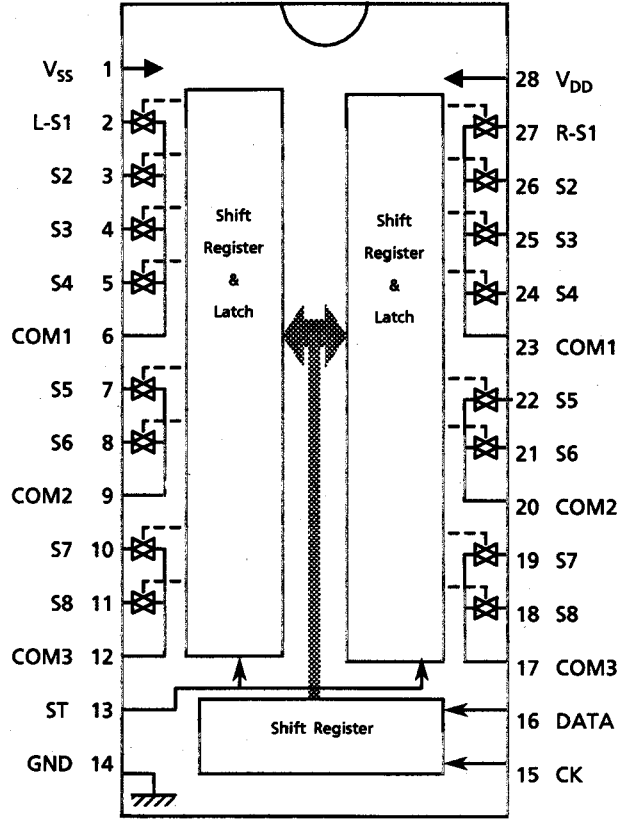

TC9164AN

3. First 10bits are used to source select. Last 4bits are chip select. The switches (S1~S8) are connected to common terminals (COM1~COM3) according to the DATA from computer.

	Chip Select Bit			
	S11	S12	S13	S14
TC9163AN	1	0	0	0
TC9164AN	0	1	0	0

■ LA2786 (IC501) : Dolby Pro Logic Surround Signal Processor

1. Terminal Layout

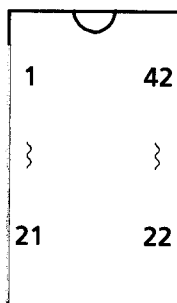

2. Pin Functions

Pin No	Symbol	I/O	Functions	Pin No	Symbol	I/O	Functions
1	NS-BPF1	--	Capacitor for spectrum filter in noise sequencer	22	VCS-1	--	Capacitor for time constant (in log differential area)
2	NS-BPF2	--	Capacitor for spectrum filter in noise sequencer	23	VCS-2	--	Capacitor for time constant (in log differential area)
3	VREF	--	Analog reference voltage	24	VCS-TH	--	Capacitor for time constant (in log differential area)
4	S-DC-OUT	--	Capacitor for DC-cut Sch	25	L+R RECT	--	Capacitor for Center channel detection
5	C-DC-OUT	--	Capacitor for DC-cut Cch	26	DC-CUT	--	Capacitor for DC-cut at detection circuit
6	L-DC-OUT	--	Capacitor for DC-cut Lch	27	L-R RECT	--	Capacitor for Surround channel detection
7	R-DC-OUT	--	Capacitor for DC-cut Rch	28	DC-CUT	--	Capacitor for DC-cut at detection circuit
8	VREF-BUFFER	--	VREF low impedance	29	R-BPF3	--	LPF,HPF for Right channel control circuit
9	L-IN	I	Left channel signal input	30	R-BPF2	--	LPF,HPF for Right channel control circuit
10	R-IN	I	Right channel signal input	31	R-BPF1	--	LPF,HPF for Right channel control circuit
11	GND	--	Ground	32	C-TRIM DC-CUT	--	Capacitor for DC-cut Center channel
12	L-BPF1	--	LPF,HPF for Lch control circuit	33	C-MODE-CAP	--	Capacitor for Center channel output low-pass filter
13	L-BPF2	--	LPF,HPF Left channel control circuit	34	C-OUT	O	Center signal output
14	L-BPF3	--	LPF,HPF Left channel control circuit	35	S-OUT	O	Surround signal output
15	DC-CUT	--	Capacitor for DC-cut at detection circuit	36	R-OUT	O	Right channel signal output
16	R RECT	--	Capacitor for Right channel detection	37	L-OUT	O	Left channel signal output
17	DC-CUT	--	Capacitor for DC-cut at detection circuit	38	VCC	--	power supply
18	L RECT	--	Capacitor for Left channel detection	39	OSC	--	Oscillation for noise sequencer and auto balance
19	VLR-TH	--	Capacitor for time constant (in log differential area)	40	STB	I	Strobe signal input
20	VLR-2	--	Capacitor for time constant (in log differential area)	41	DATA	I	Serial interface data input
21	VLR-1	--	Capacitor for time constant (in log differential area)	42	CLK	I	Serial interface clock

AX-V5BK

■ LV1016 (IC541) : Dolby Surround Passive Decoder

1. Terminal Layout

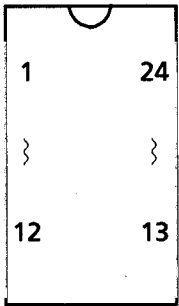

2. Block Diagram

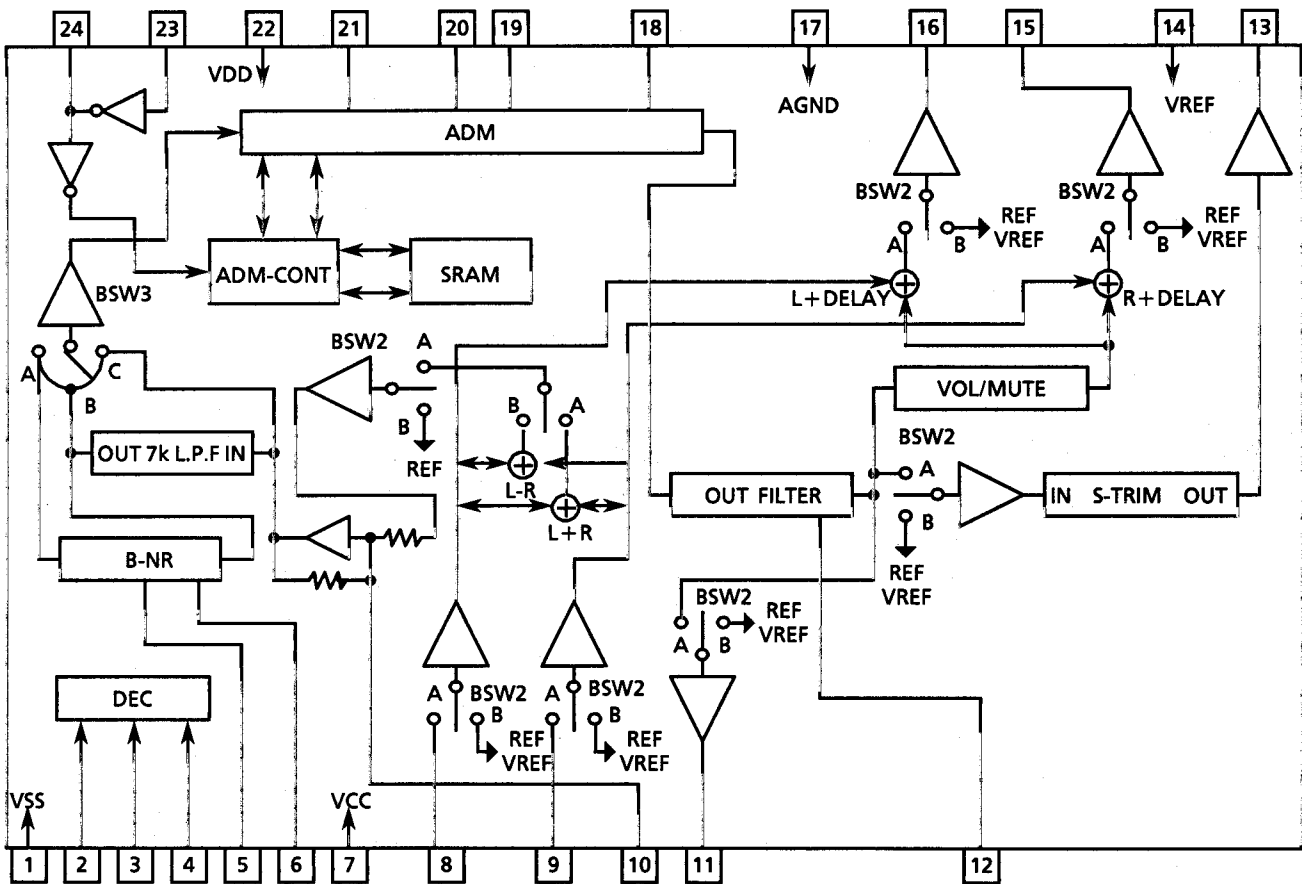

3. Pin Functions

Pin No.	Symbol	I/O	Functions
1	DGND	--	Digital GND
2	CLK	I	Serial interface clock
3	DATA	I	Serial interface data input
4	STB	I	Strobe signal input
5	NR-DET	--	Capacitor for noise reduction detection
6	NR-IREF	--	Resistor for noise reduction reference current
7	VCC	--	Supply
8	L-IN	I	Left channel signal input
9	R-IN	I	Right channel signal input
10	S-IN	I	Surround signal input
11	DELAY-OUT	--	Not used
12	DC-CUT	--	Capacitor for DC-cut
13	S-OUT	O	Surround signal output
14	VREF	--	Analog reference voltage
15	R-MIX-OUT	--	Not used
16	L-MIX-OUT	--	Not used
17	ADND	--	Analog ground
18	DC-CUT	--	Capacitor for DC-cut
19	D/A	--	Capacitor for integrator
20	NOISE SHAPER	--	Capacitor for noise shaper
21	A/D	--	Capacitor for integrator
22	VDD	--	Supply for the digital section
23	OSC	--	Oscillation terminal
24	OSC	--	Oscillation terminal

Disassembly Procedures

■ Top cover removal

1. Remove 4 screws **A** on both sides of the top cover and 3 screws **B** on the rear side.(FIG.1)
2. Lift the back of the top cover spreading both sides to remove.

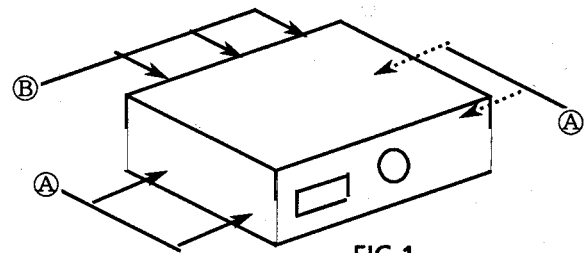

FIG.1

■ Front panel assembly removal

1. Remove the top cover.
2. Remove 3 screws **K** on the bottom side and 3 screws **C** on the top side.(FIG.2,4)
3. Disconnect the wires CN304 and CN801.
4. Cut the tie bands on the tuner p.c.board and ENC-135-6. And cut the tie bands CN801 wires.
5. Remove 2 hooks on both sides of the front panel assembly.
6. Remove the front panel assembly.

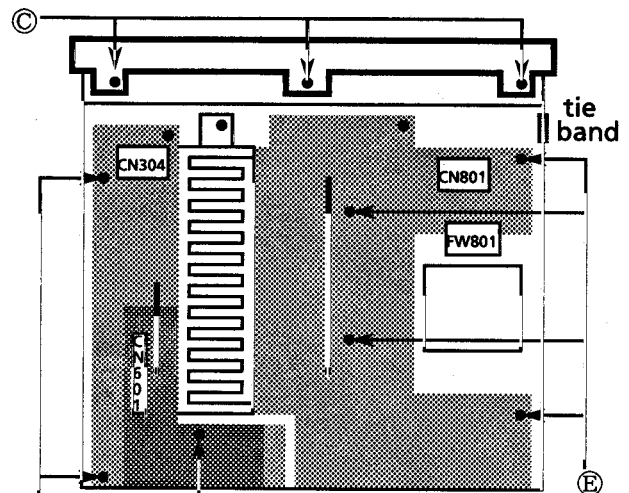

FIG.2 Top side

■ Video P.C.Board removal

1. Remove the top cover.
2. Remove 5 screws **D** and **F**.(FIG.2,3)
3. Disconnect the connector CN601.
4. Remove the video P.C.Board(ENC-135-2).

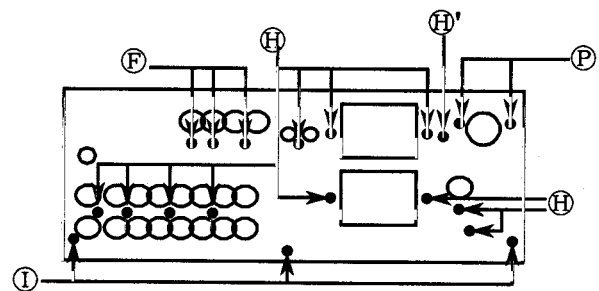

FIG.3 Rear side

■ Rear panel removal

1. Remove the top cover.
2. Remove 18 screws **F**, **H**, **H'** and **I**.
(Not used **H'** for Universal type.)
(Remove 2 screws **P**. Only used Universal type.)
(FIG.3)
3. Remove the power cord stopper up side.
4. Remove the rear panel.

■ Main amp. P.C.Board with same P.C.Board and front panel assembly removal

1. Remove the top cover.
2. Cut the tie band bottom base left front side.
3. Remove 3 screws **L**.(FIG.3)
4. Remove 4 screws **O**.(FIG.4)
5. Remove 3 screws **L**.(FIG.4)
6. Remove 6 screws **E**.(FIG.2)
7. Lift the right side of the P.C.Board ass'y to remove the bottom base.

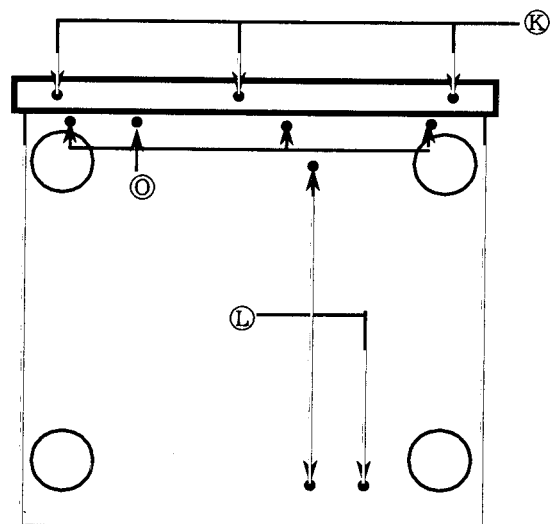

FIG.4 Bottom side

AX-V5BK

■ Front P.C. Board removal

1. Remove the top cover.
2. Remove the front panel assembly.
3. Remove the master volume knob and nut.
4. Remove 13 screws (M).(FIG.5)
5. Remove the front P.C. Board.

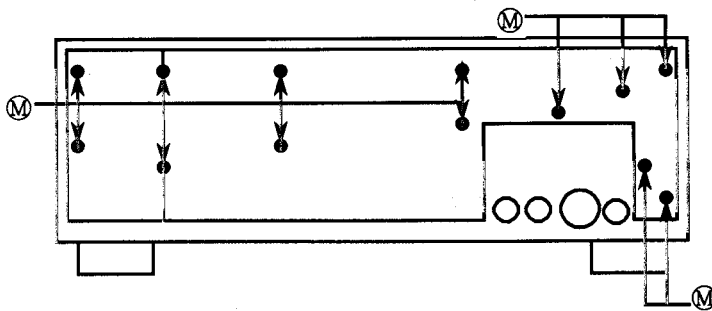

FIG.5 Front panel ass'y rear side

■ Power Transistor removal

1. Remove the top cover.
2. Remove the front panel assembly.
3. Remove the main amp. P.C.Board with same P.C.Board.
4. Unsolder the broken transistor.
5. Remove the some screws (N) fastening it.(FIG.6)

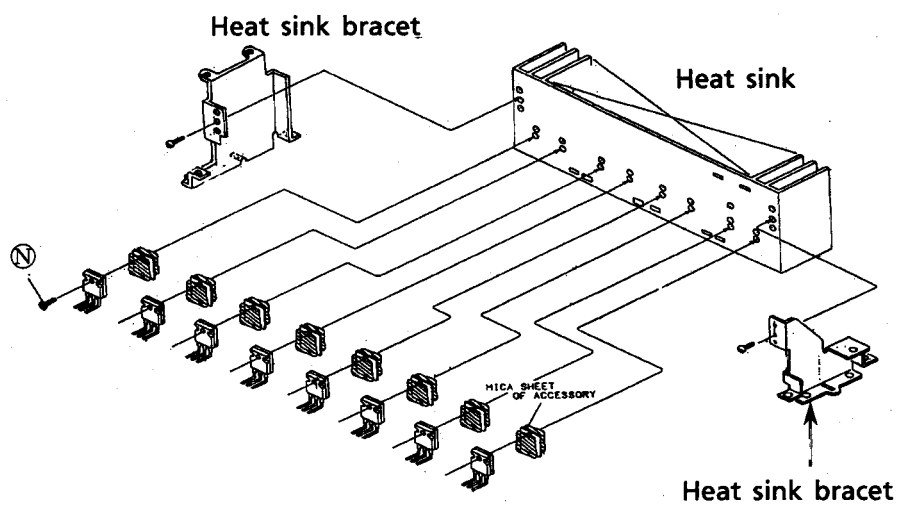
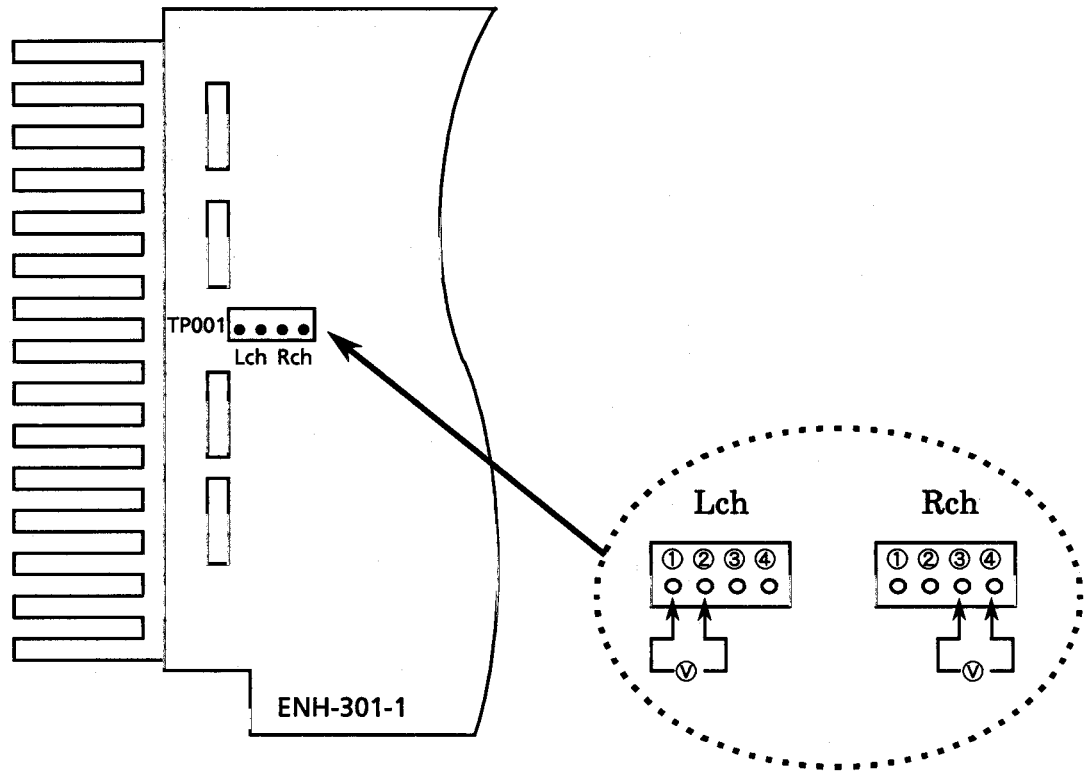

FIG.6

ADJUSTMENT PROCEDURES

■ Power Amplifier section

Front said



■ Idling current

- (1) Set the volume control to minimum during this adjustment.
 - * Set the surround mode "ON". Areas for BS,EF,EN,G.
 - * Set the surround mode "OFF". Areas for US,UT,U.
- (2) Turn VR741 and VR742 fully counterclockwise to warm up before adjustment.
If the heatsink is already warm from previous use the correct adjustment can not be made.
- (3) For L-ch, connect a DC voltmeter between TP001's pin1 and pin2 (Lch).
And, connect it between pin3 and pin4(Rch).
- (4) Appox. 30minutes later after power on, adjust VR741 for L-ch , or VR742 for R-ch so that the DC voltmeters value has 1mV~3mV.

The Marks for Designated Areas

BS	the U.K.	EF	Continental Europe	EN ...	Nordic Countries
G	Germany	US	Singapore	UT ...	Taiwan
U	Universal				

No mark indicates all area.

Block Diagrams

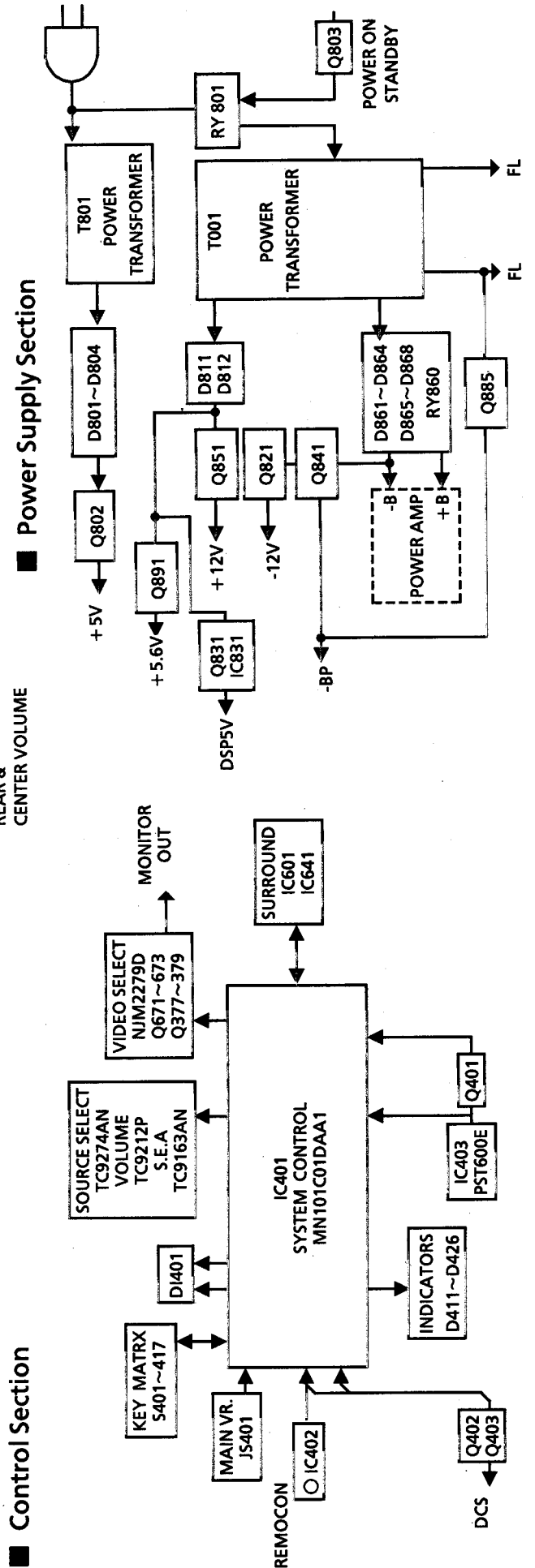
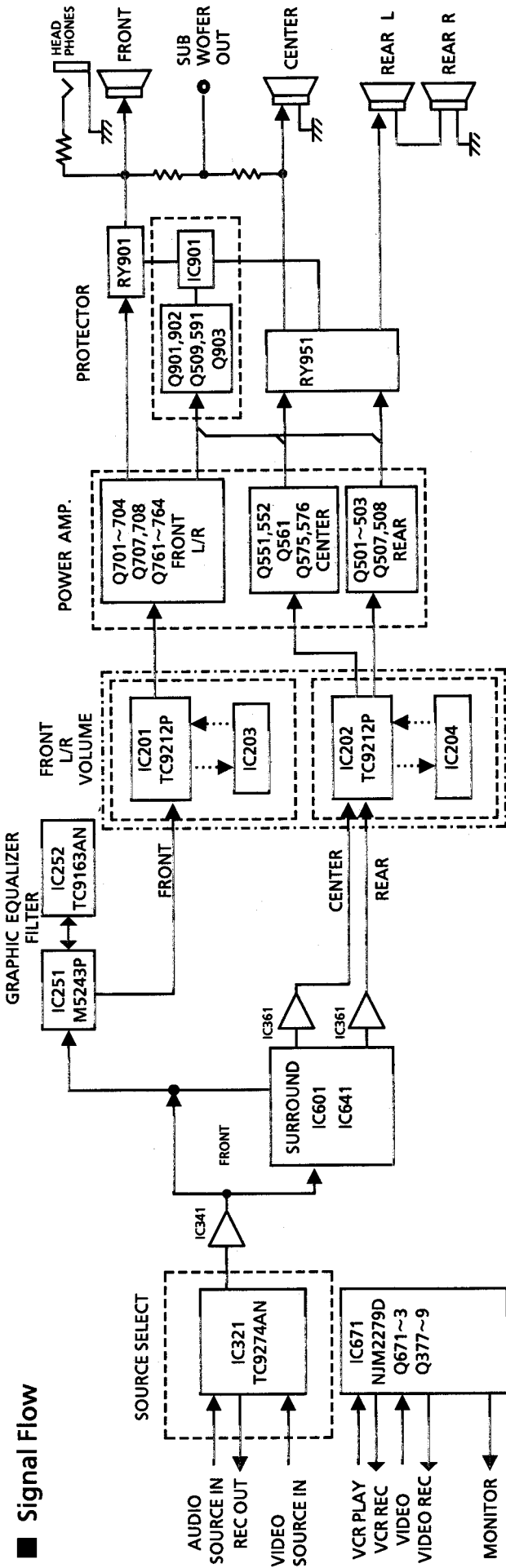

Printed Circuit Boards
MAIN AMP. P.C.BORD(ENH-301)

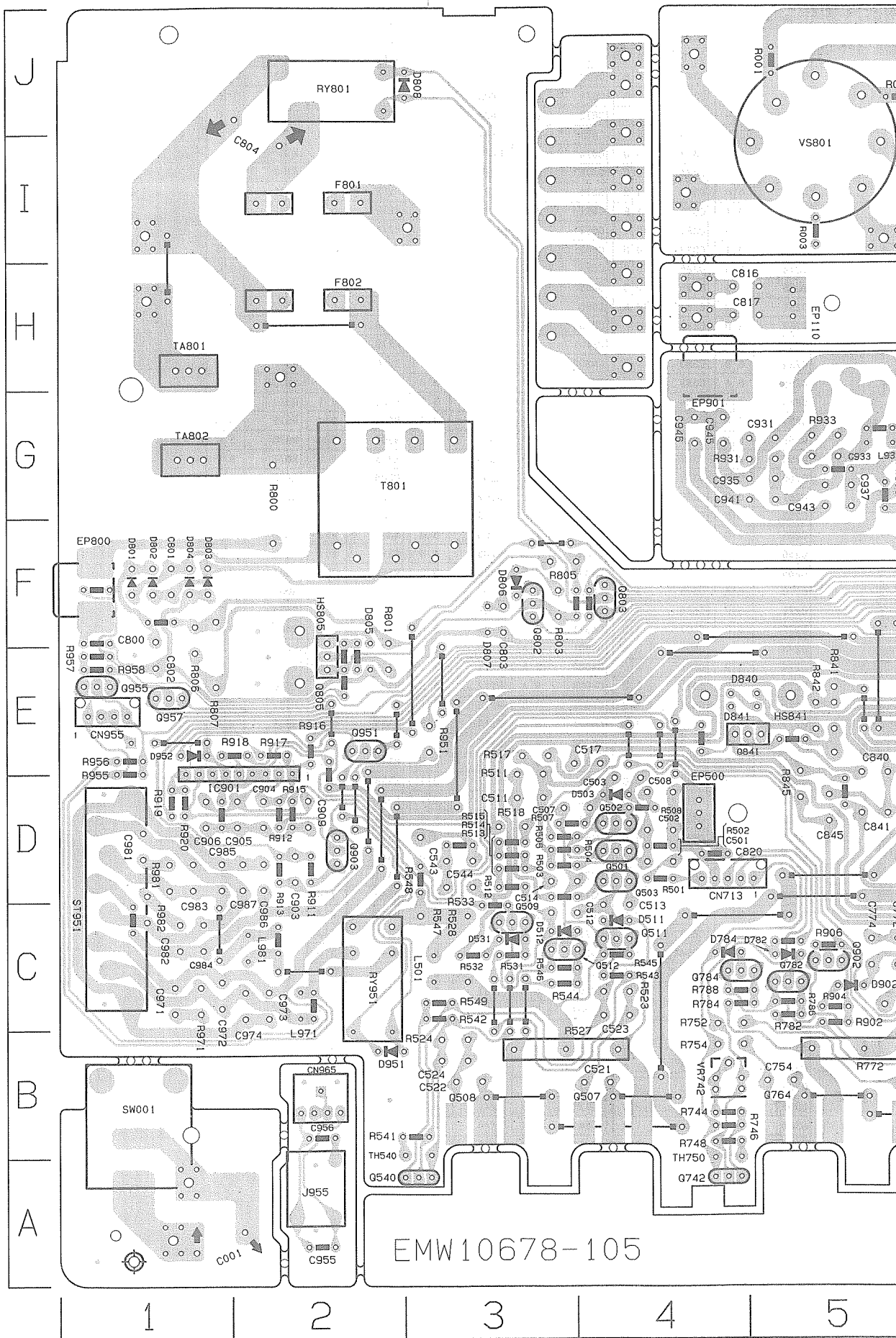

EMW10678-105

Location List (ENH-301)

Symbol	X	Y	Symbol	X	Y	Symbol	X	Y	Symbol	X	Y	Symbol	X	Y	Symbol	X	Y
C001	1	A	C932	6	G	D885	9	E	Q902	5	C	R782	5	C	RY801	2	J
C501	4	D	C933	5	G	D891	9	D	Q903	2	D	R783	8	C	RY860	8	G
C502	4	D	C934	6	G	D901	7	C	Q951	2	E	R784	5	C	RY901	8	F
C503	4	D	C935	5	G	D902	5	C	Q955	1	E	R785	8	C	RY951	2	B
C507	4	D	C936	6	G	D921	8	F	Q956	9	F	R786	5	C	S901A	10	H
C508	4	D	C937	5	G	D925	8	H	Q957	1	E	R787	7	C	S901B	10	H
C511	3	D	C938	6	G	D951	2	B	R001	5	J	R788	4	C	ST901	5	H
C512	3	C	C941	5	G	D952	1	E	R002	5	J	R800	2	F	ST951	1	D
C513	4	C	C942	6	G	F801	2	I	R003	5	I	R801	2	F	SW001	1	B
C514	3	D	C943	5	G	F802	2	H	R501	4	D	R803	3	F	T801	2	G
C517	4	E	C944	6	G	F803	6	I	R502	4	D	R805	3	F	TA801	1	H
C521	4	B	C945	4	G	F811	7	H	R503	3	D	R806	1	F	TA802	1	G
C522	3	B	C946	4	G	F812	7	G	R504	3	D	R807	1	F	TH540	3	B
C523	4	C	C955	2	A	FW801	7	J	R505	3	D	R808	7	J	TH568	10	B
C524	3	B	C956	2	B	FW801B	8	J	R507	4	D	R811	10	D	TH749	8	B
C543	3	D	C961	10	J	FW831	10	H	R508	4	D	R812	10	D	TH750	4	B
C544	3	D	C962	10	J	FW901A	5	G	R511	3	D	R821	9	D	TP001	6	B
C571	8	B	C971	1	C	FW901B	10	G	R512	3	D	R822	9	D			
C572	9	B	C972	1	C	FW902	8	E	R513	3	D	R830	9	I			
C581	9	C	C973	2	C	FW902B	9	G	R514	3	D	R831	9	I			
C582	9	C	C974	2	C	FW961	10	J	R515	3	D	R832	10	I			
C751	7	B	C981	1	D	FW961A	10	G	R517	3	E	R840	9	F			
C752	6	B	C982	1	C	IC831	10	B	R518	3	D	R841	5	E			
C753	7	B	C983	1	D	IC901	2	E	R523	4	C	R842	5	E			
C754	5	B	C984	1	C	J955	2	A	R524	3	B	R845	5	D			
C771	7	C	C985	1	D	J961	9	J	R527	4	B	R852	10	F			
C772	5	C	C986	2	D	L501	3	C	R528	3	C	R853	10	F			
C773	7	C	C987	2	D	L581	9	C	R531	3	C	R854	10	E			
C774	5	C	CN711	8	D	L771	7	B	R532	3	C	R859	9	G			
C800	1	F	CN713	5	D	L772	6	B	R533	3	C	R860	9	F			
C801	1	F	CN801	9	G	L931	5	G	R541	2	B	R861	8	F			
C802	1	F	CN831	10	D	L932	6	G	R542	3	C	R862	8	F			
C803	3	F	CN851	10	C	L971	2	C	R543	4	C	R885	9	E			
C804	2	I	CN955	1	E	L981	2	C	R544	3	C	R891	9	E			
C808	8	J	CN965	2	B	Q501	4	D	R545	4	C	R892	9	E			
C811	9	F	D503	4	D	Q502	4	D	R546	3	C	R901	7	C			
C812	8	G	D511	4	C	Q503	4	D	R547	3	D	R902	5	C			
C813	8	I	D512	3	C	Q507	4	B	R548	3	D	R903	7	C			
C814	10	C	D531	3	C	Q508	3	B	R549	3	C	R904	5	C			
C815	10	D	D585	9	C	Q509	3	C	R562	10	B	R905	7	C			
C816	5	H	D586	10	C	Q511	4	C	R567	10	B	R906	5	C			
C817	5	H	D591	9	C	Q512	3	C	R571	10	C	R909	7	C			
C820	4	D	D781	8	C	Q540	3	A	R572	10	C	R910	6	C			
C821	9	D	D782	5	C	Q568	10	A	R576	10	B	R911	2	D			
C822	9	D	D783	7	C	Q575	8	B	R577	9	B	R912	2	D			
C831	10	D	D784	4	C	Q576	9	B	R581	9	C	R913	2	D			
C832	10	D	D801	1	F	Q585	9	C	R582	8	B	R915	2	D			
C834	10	B	D802	1	F	Q586	10	C	R585	9	C	R916	2	E			
C840	5	E	D803	1	F	Q591	9	C	R586	10	C	R917	2	E			
C841	5	D	D804	1	F	Q741	8	A	R587	9	C	R918	2	E			
C845	5	D	D805	2	E	Q742	4	A	R588	10	C	R919	1	D			
C853	10	D	D806	3	F	Q761	6	B	R591	9	C	R920	1	D			
C854	10	D	D807	3	F	Q762	5	B	R592	9	C	R921	8	F			
C860	8	H	D808	3	J	Q763	7	B	R593	9	C	R925	8	I			
C861	7	E	D811	8	H	Q764	5	B	R594	8	C	R926	8	I			
C862	6	E	D812	8	H	Q781	8	C	R743	8	B	R927	8	I			
C863	8	H	D815	10	D	Q782	5	C	R744	4	B	R929	8	E			
C864	9	H	D822	9	D	Q783	8	C	R745	8	B	R930	8	E			
C865	8	I	D831	10	C	Q784	5	C	R746	4	B	R931	5	G			
C866	9	I	D832	9	D	Q802	3	F	R747	8	B	R932	6	G			
C867	8	J	D840	4	E	Q803	4	F	R748	4	B	R933	5	G			
C868	8	J	D841	4	E	Q805	2	E	R751	8	C	R934	6	G			
C869	7	I	D851	10	D	Q811	10	D	R752	4	C	R951	3	E			
C885	9	E	D860	9	G	Q821	9	E	R753	8	B	R955	1	E			
C896	9	D	D861	9	H	Q831	10	I	R754	4	B	R956	1	E			
C903	2	D	D862	9	H	Q841	4	E	R771	7	B	R957	1	E			
C904	2	D	D863	9	I	Q851	10	E	R772	5	B	R958	1	E			
C905	2	D	D864	9	I	Q860	9	F	R773	7	C	R961	10	F			
C906	1	D	D865	9	J	Q861	9	G	R774	5	C	R962	10	F			
C909	2	D	D866	9	I	Q885	9	E	R775	7	C	R971	1	C			
C925	8	H	D867	9	J	Q891	9	E	R776	5	C	R981	1	D			
C931	5	G	D868	9	J	Q901	7	C	R781	8	C	R982	1	C			

INPUT P.C. BOARD (ENC-135)

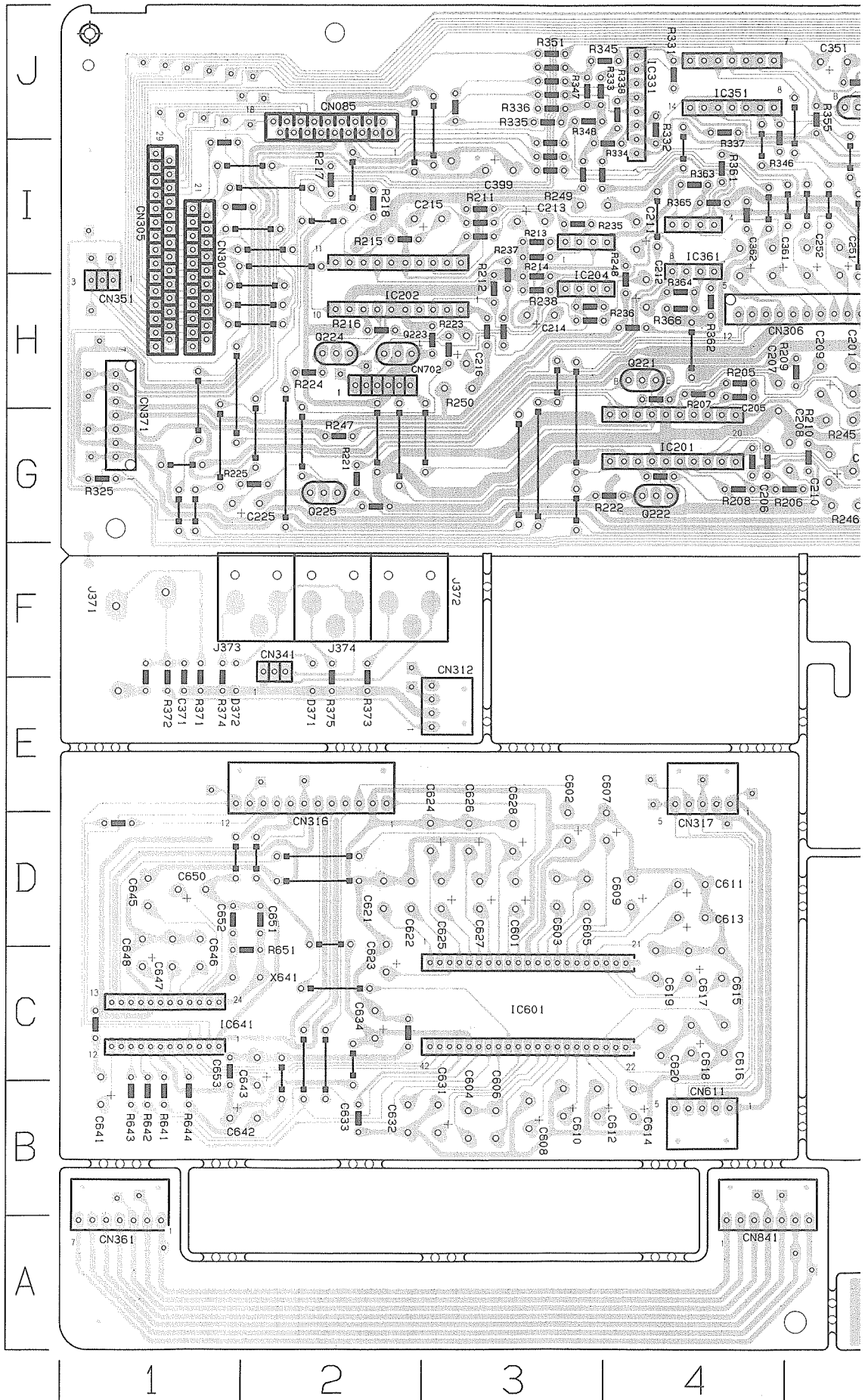

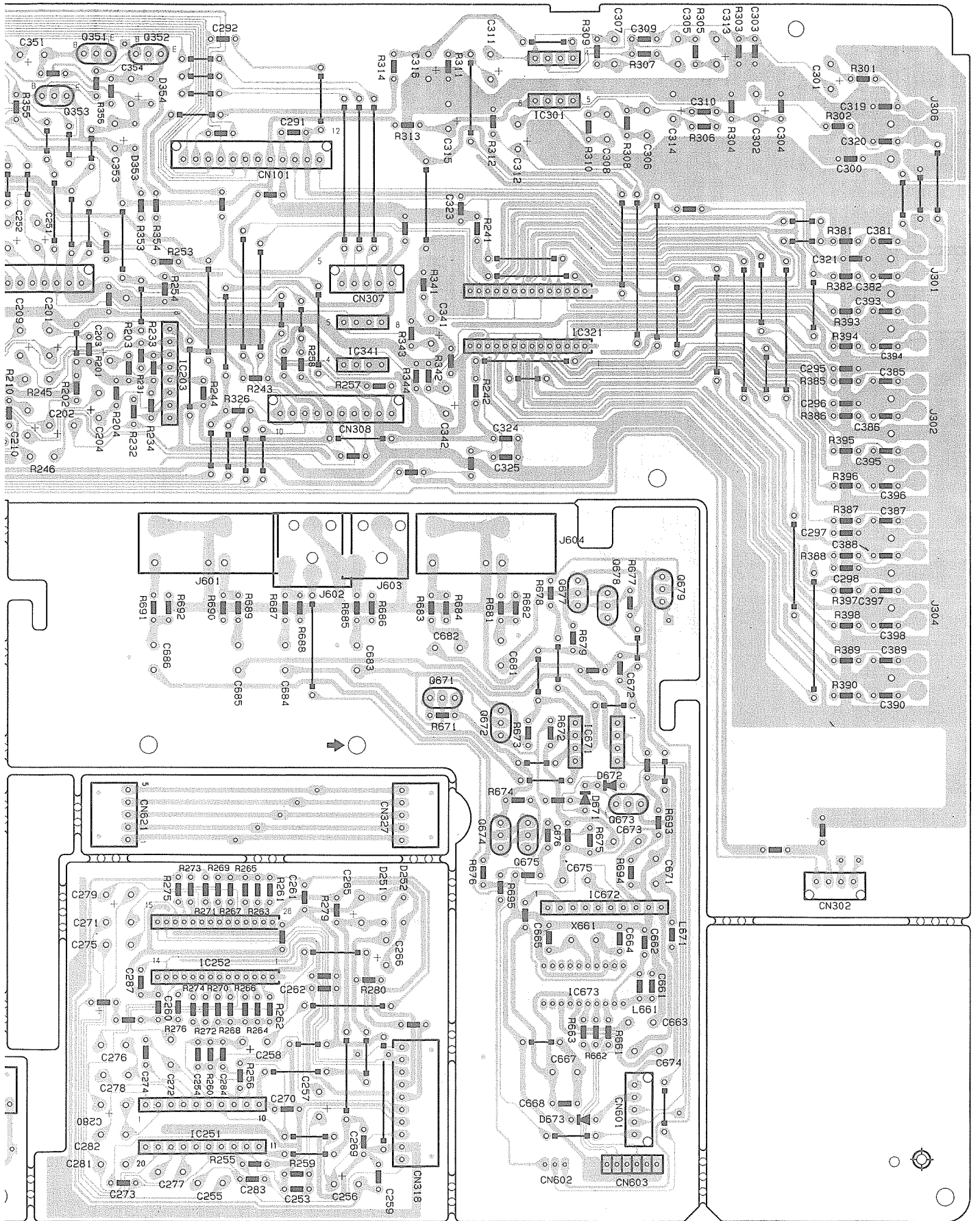

5

6

7

8

9

10

Location List (ENC-135)

Symbol	X	Y	Symbol	X	Y	Symbol	X	Y	Symbol	X	Y	Symbol	X	Y	Symbol	X	Y
C201	5	H	C320	10	I	C662	9	C	J371	1	F	R258	6	H	R386	10	G
C202	5	G	C321	10	H	C663	8	B	J372	2	F	R259	6	A	R387	10	F
C203	5	H	C323	7	I	C664	8	C	J373	2	F	R260	6	B	R388	10	F
C204	5	G	C324	8	G	C665	8	C	J374	2	F	R261	6	C	R389	10	E
C205	4	H	C325	8	G	C667	8	B	J601	6	F	R262	6	B	R390	10	E
C206	4	G	C341	7	H	C668	8	A	J602	6	F	R263	6	C	R393	10	H
C207	4	G	C342	7	G	C671	9	C	J603	7	F	R264	6	B	R394	10	H
C208	5	G	C351	5	J	C672	8	E	J604	8	F	R265	6	C	R395	10	G
C209	5	H	C353	5	I	C673	8	D	L661	8	B	R266	6	B	R396	10	G
C210	5	G	C354	5	J	C674	8	B	L671	9	C	R267	6	C	R397	10	F
C211	4	I	C361	4	H	C675	8	C	Q221	4	H	R268	6	B	R398	10	E
C212	4	H	C362	4	H	C676	8	D	Q222	4	G	R269	6	C	R641	1	B
C213	3	I	C371	1	E	C681	8	E	Q223	2	H	R270	6	B	R642	1	B
C214	3	H	C381	10	I	C682	7	E	Q224	2	H	R271	6	C	R643	1	B
C215	2	I	C382	10	H	C683	7	E	Q225	2	G	R272	6	B	R644	1	B
C216	3	H	C385	10	G	C684	6	E	Q351	5	J	R273	6	C	R651	2	C
C225	1	G	C386	10	G	C685	6	E	Q352	5	J	R274	6	B	R661	8	B
C251	5	H	C387	10	F	C686	6	E	Q353	5	J	R275	6	C	R662	8	B
C252	5	H	C388	10	F	CN085	2	J	Q671	7	E	R276	6	B	R663	8	B
C253	6	A	C389	10	E	CN101	7	I	Q672	8	D	R279	7	C	R671	7	E
C254	6	B	C390	10	E	CN302	10	C	Q673	8	D	R280	7	B	R672	8	E
C255	6	A	C393	10	H	CN304	1	H	Q674	8	D	R301	10	J	R673	8	E
C256	7	A	C394	10	H	CN305	1	H	Q675	8	D	R302	10	I	R674	8	D
C257	7	A	C395	10	G	CN306	5	H	Q677	8	F	R303	9	J	R675	8	D
C258	6	B	C396	10	G	CN307	7	H	Q678	8	E	R304	9	J	R676	8	C
C259	7	A	C397	10	F	CN308	7	G	Q679	9	F	R305	9	J	R677	8	F
C260	6	B	C398	10	E	CN312	3	E	R201	5	H	R306	9	I	R678	8	F
C261	6	C	C399	3	I	CN316	2	E	R202	5	G	R307	9	J	R679	8	E
C262	6	B	C601	3	D	CN317	4	E	R203	5	G	R308	8	I	R681	8	F
C265	7	C	C602	3	D	CN318	7	A	R204	5	G	R309	8	J	R682	8	F
C266	7	C	C603	3	D	CN327	7	D	R205	4	H	R310	8	I	R683	7	F
C269	7	A	C604	3	B	CN341	2	F	R206	5	G	R311	7	J	R684	7	E
C270	6	A	C605	3	D	CN351	1	H	R207	4	H	R312	8	I	R685	7	F
C271	5	C	C606	3	B	CN361	1	A	R208	4	G	R313	7	J	R686	7	F
C272	6	B	C607	4	D	CN371	1	G	R209	5	H	R314	7	J	R687	6	F
C273	5	A	C608	3	B	CN601	8	A	R210	5	G	R325	1	G	R688	6	E
C274	5	B	C609	4	D	CN602	8	A	R211	3	I	R326	6	G	R689	6	F
C275	5	C	C610	3	B	CN603	9	A	R212	3	H	R331	4	J	R690	6	E
C276	5	B	C611	4	D	CN611	4	B	R213	3	I	R332	4	J	R691	6	F
C277	6	A	C612	3	B	CN621	5	D	R214	3	H	R333	3	J	R692	6	F
C278	5	B	C613	4	D	CN702	2	H	R215	2	I	R334	3	I	R693	9	D
C279	5	C	C614	4	B	CN841	5	A	R216	2	H	R335	3	J	R694	8	C
C280	5	A	C615	4	C	D251	7	C	R217	2	I	R336	3	J	R695	8	C
C281	5	A	C616	4	C	D252	7	C	R218	2	I	R337	4	J	X641	2	C
C282	5	A	C617	4	C	D353	5	J	R221	2	G	R338	4	J	X661	8	C
C283	6	A	C618	4	C	D354	5	J	R222	4	G	R341	7	H			
C284	6	B	C619	4	C	D371	2	E	R223	3	H	R342	7	H			
C287	5	B	C620	4	C	D372	1	E	R224	2	H	R343	7	H			
C291	6	I	C621	2	D	D671	8	D	R225	2	G	R344	7	H			
C292	6	J	C622	2	D	D672	8	D	R231	5	H	R345	4	J			
C295	10	H	C623	2	C	D673	8	A	R232	5	G	R346	4	J			
C296	10	G	C624	3	D	IC201	4	G	R233	6	G	R347	3	J			
C297	10	F	C625	3	D	IC202	3	H	R234	5	G	R348	3	J			
C298	10	F	C626	3	D	IC203	6	G	R235	3	I	R351	3	J			
C300	10	I	C627	3	D	IC204	3	I	R236	3	H	R353	5	I			
C301	10	J	C628	3	D	IC251	5	A	R237	3	I	R354	6	I			
C302	9	J	C631	3	B	IC252	6	C	R238	3	H	R355	5	J			
C303	9	J	C632	2	B	IC301	8	J	R241	7	I	R356	5	J			
C304	9	J	C633	2	B	IC321	8	H	R242	7	G	R361	4	I			
C305	9	J	C634	2	C	IC331	4	J	R243	6	G	R362	4	H			
C306	9	I	C641	1	B	IC341	7	H	R244	6	G	R363	4	I			
C307	8	J	C642	1	B	IC351	4	J	R245	5	G	R364	4	H			
C308	8	I	C643	2	B	IC361	4	I	R246	5	G	R365	4	I			
C309	8	J	C645	1	D	IC601	3	C	R247	2	G	R366	4	H			
C310	9	J	C646	1	D	IC641	1	C	R248	4	H	R371	1	F			
C311	8	J	C647	1	D	IC671	8	E	R249	4	I	R372	1	F			
C312	8	I	C648	1	C	IC672	8	C	R250	3	H	R373	2	E			
C313	9	J	C650	1	D	IC673	8	B	R253	6	H	R374	1	F			
C314	9	J	C651	2	D	J301	10	H	R254	6	H	R375	2	F			
C315	7	I	C652	1	D	J302	10	G	R255	6	A	R381	10	I			
C316	7	J	C653	1	B	J304	10	E	R256	6	B	R382	10	H			
C319	10	J	C661	9	C	J306	10	J	R257	7	G	R385	10	G			

FRONT P.C.BOARD (ENB-246)

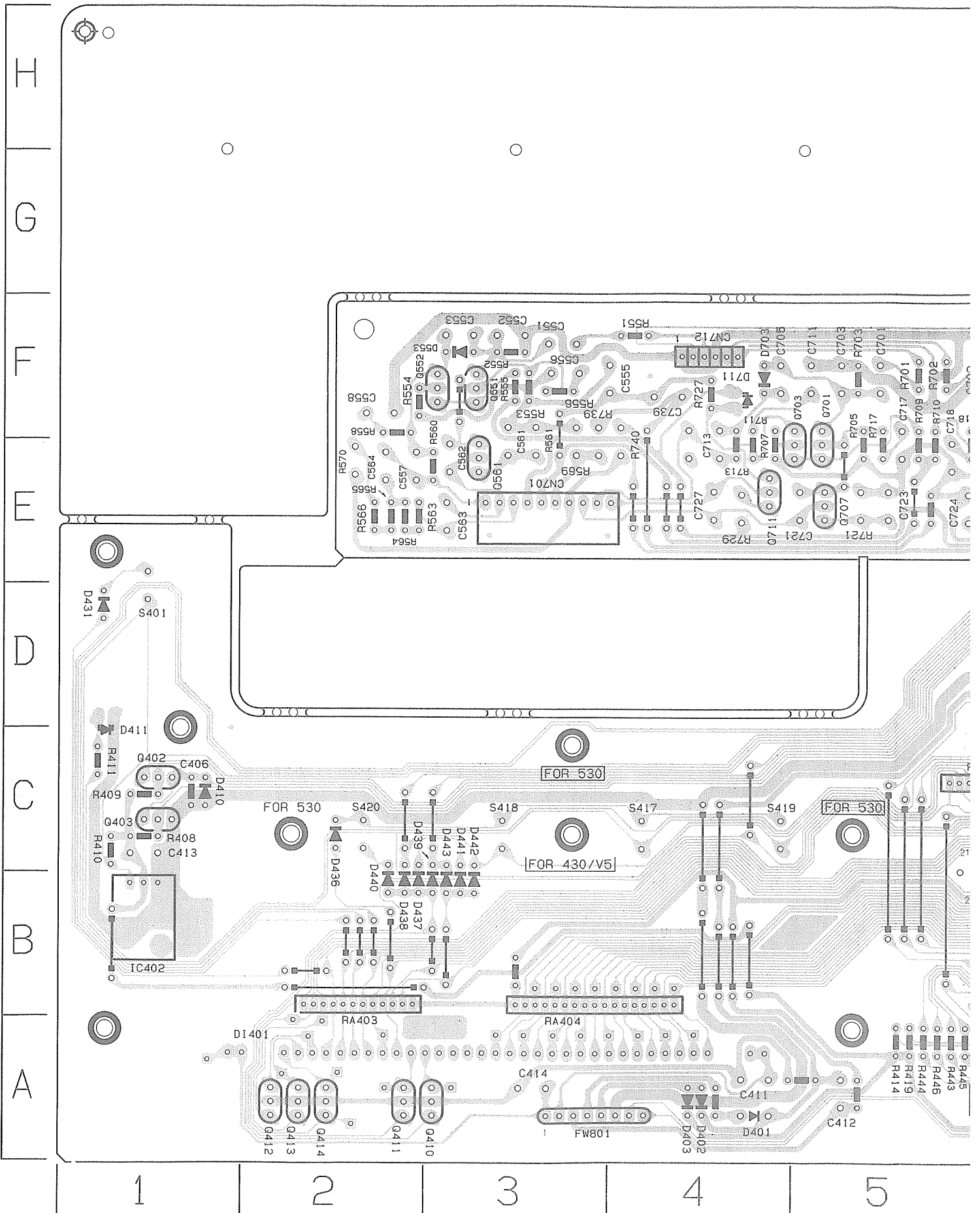

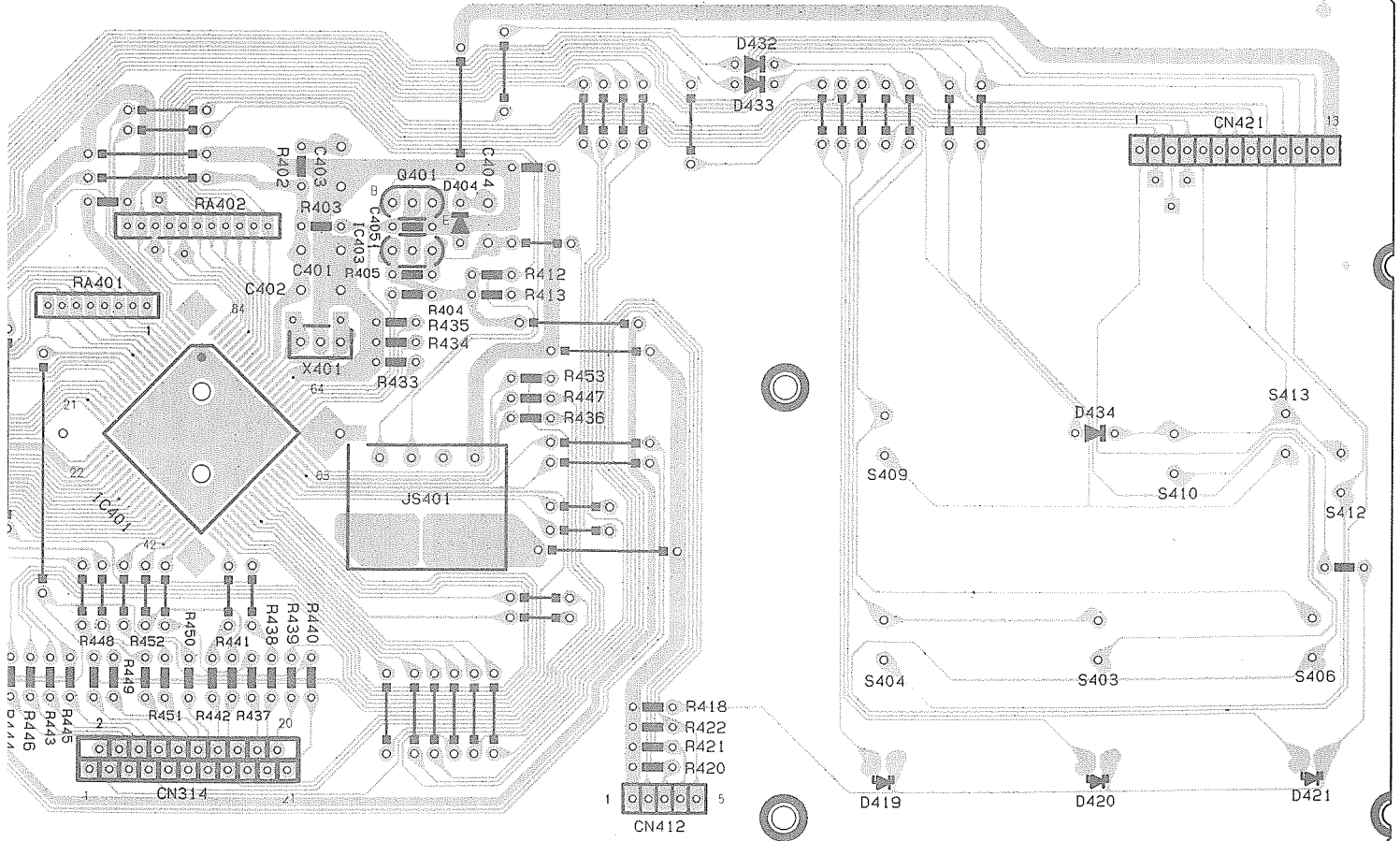
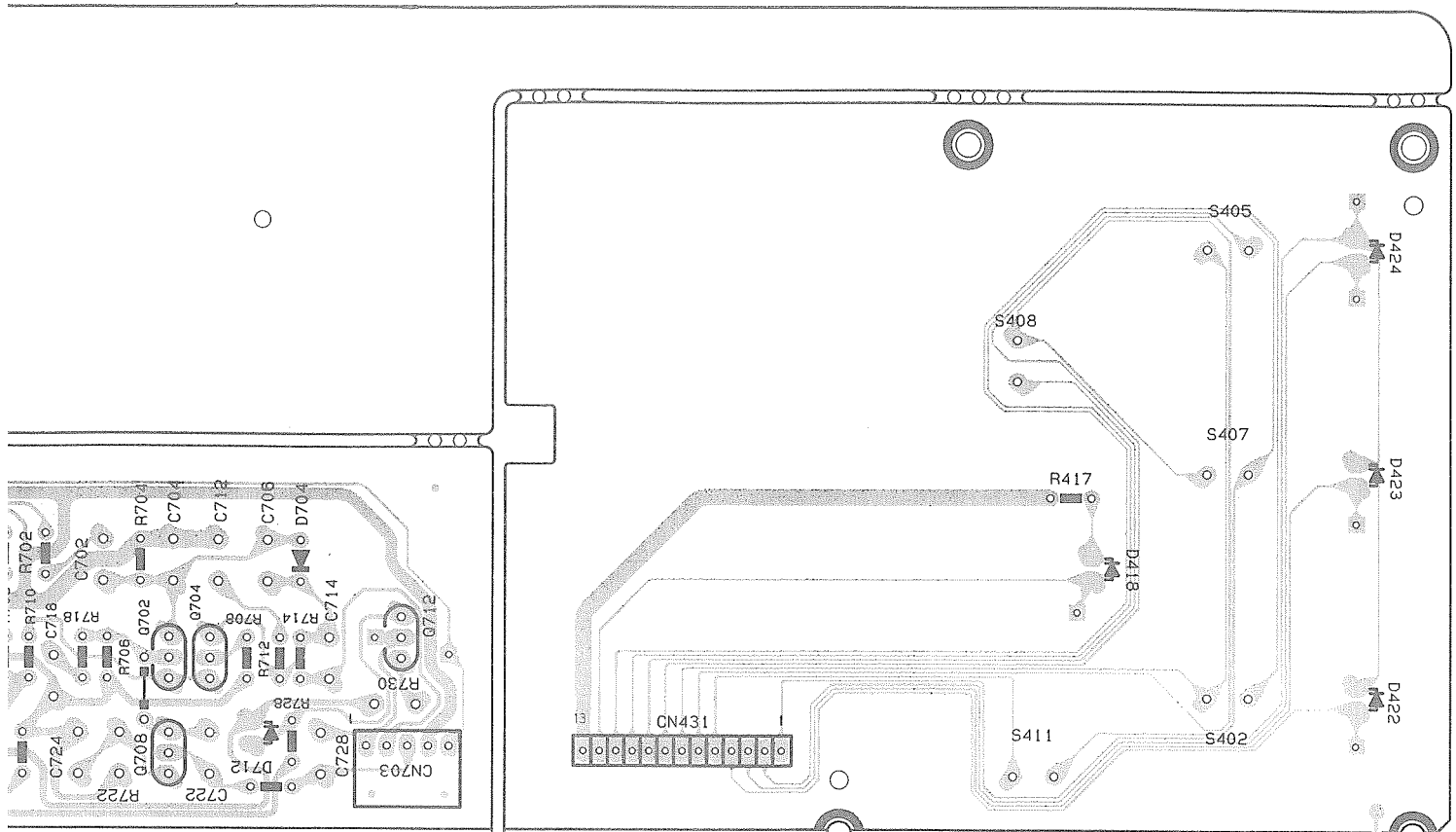

6

7

8

9

10

Location List (ENB-246)

Symbol	X	Y	Symbol	X	Y	Symbol	X	Y
C401	6	C	D553	3	F	R555	3	F
C402	6	C	D703	4	F	R556	3	F
C403	6	D	D704	6	F	R558	2	F
C404	7	C	D711	4	F	R560	3	E
C405	7	D	D712	6	E	R561	3	E
C406	1	C	D1401	4	A	R563	2	E
C411	4	A	FW801	3	A	R564	2	E
C412	5	A	1C401	6	C	R565	2	E
C413	1	C	1C402	1	B	R566	2	E
C414	3	A	1C403	7	C	R569	3	E
C551	3	F	JS401	7	B	R570	2	E
C552	3	F	Q401	7	D	R701	5	F
C553	3	F	Q402	1	C	R702	5	F
C555	3	F	Q403	1	C	R703	5	F
C556	3	F	Q410	3	A	R704	6	F
C557	2	E	Q411	2	A	R705	5	F
C558	2	F	Q412	2	A	R706	6	F
C561	3	F	Q413	2	A	R707	4	F
C562	3	E	Q414	2	A	R708	6	F
C563	3	E	Q551	3	F	R709	5	E
C564	2	E	Q552	3	F	R710	5	E
C701	5	F	Q561	3	E	R711	4	F
C702	6	F	Q701	5	F	R712	6	F
C703	5	F	Q702	6	F	R713	4	F
C704	6	F	Q703	5	F	R714	6	F
C705	4	F	Q704	6	F	R717	5	F
C706	6	F	Q707	5	E	R718	5	F
C711	5	F	Q708	6	E	R721	5	E
C712	6	F	Q711	4	E	R722	6	E
C713	4	F	Q712	7	F	R727	4	F
C714	6	F	R402	6	D	R728	6	E
C717	5	E	R403	6	D	R729	4	E
C718	5	E	R404	7	C	R730	7	E
C721	5	E	R405	7	C	R739	3	F
C722	6	E	R408	1	C	R740	4	F
C723	5	E	R409	1	C	RA401	6	C
C724	5	E	R410	1	C	RA402	6	D
C727	4	E	R411	1	C	RA403	2	B
C728	6	E	R412	7	C	RA404	3	B
C739	4	F	R413	7	C	S401	1	D
CN314	6	A	R414	5	A	S402	10	E
CN412	8	A	R417	9	F	S403	9	B
CN421	10	D	R418	8	A	S404	9	B
CN431	8	E	R419	5	A	S405	10	G
CN701	3	E	R420	8	A	S406	10	B
CN703	7	E	R421	8	A	S407	10	F
CN712	4	F	R422	8	A	S408	9	G
D401	4	A	R433	7	C	S409	9	C
D402	4	A	R434	7	C	S410	10	B
D403	4	A	R435	7	C	S411	9	E
D404	7	C	R436	7	C	S412	10	B
D410	1	C	R437	6	A	S413	10	C
D411	1	D	R438	6	A	S417	4	C
D418	9	F	R439	6	A	S418	3	C
D419	9	A	R440	6	A	S419	4	C
D420	9	A	R441	6	A	S420	2	C
D421	10	A	R442	6	A	X401	6	C
D422	10	E	R443	5	A			
D423	10	F	R444	5	A			
D424	10	G	R445	5	A			
D431	1	D	R446	5	A			
D432	8	D	R447	7	C			
D433	8	D	R448	6	A			
D434	9	C	R449	6	A			
D436	2	C	R450	6	A			
D437	2	B	R451	6	A			
D438	2	B	R452	6	A			
D439	3	B	R453	7	C			
D440	2	B	R551	4	F			
D441	3	B	R552	3	F			
D442	3	B	R553	3	F			
D443	3	B	R554	2	F			

AX-V5BK

-MEMO-

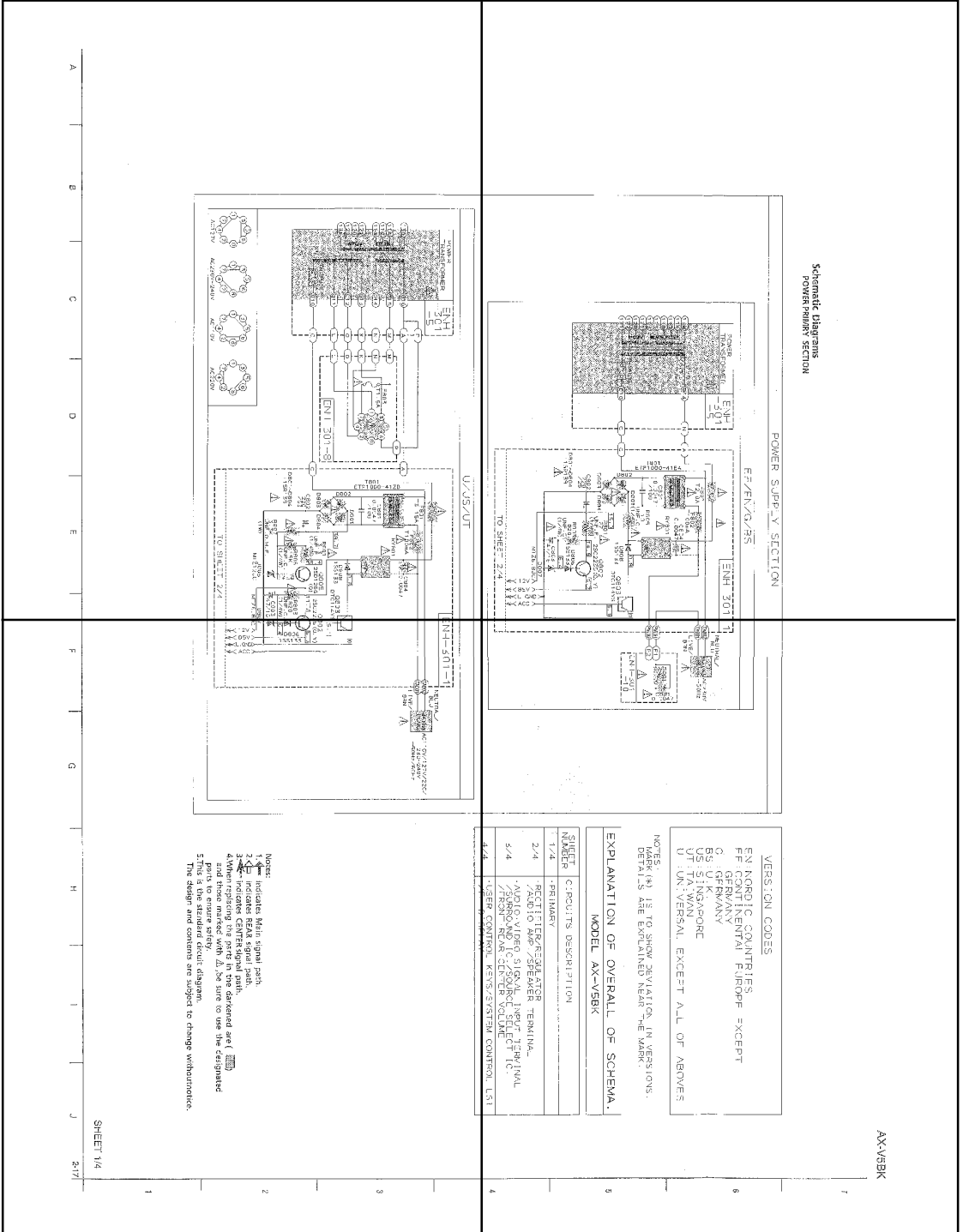

U/US/UT

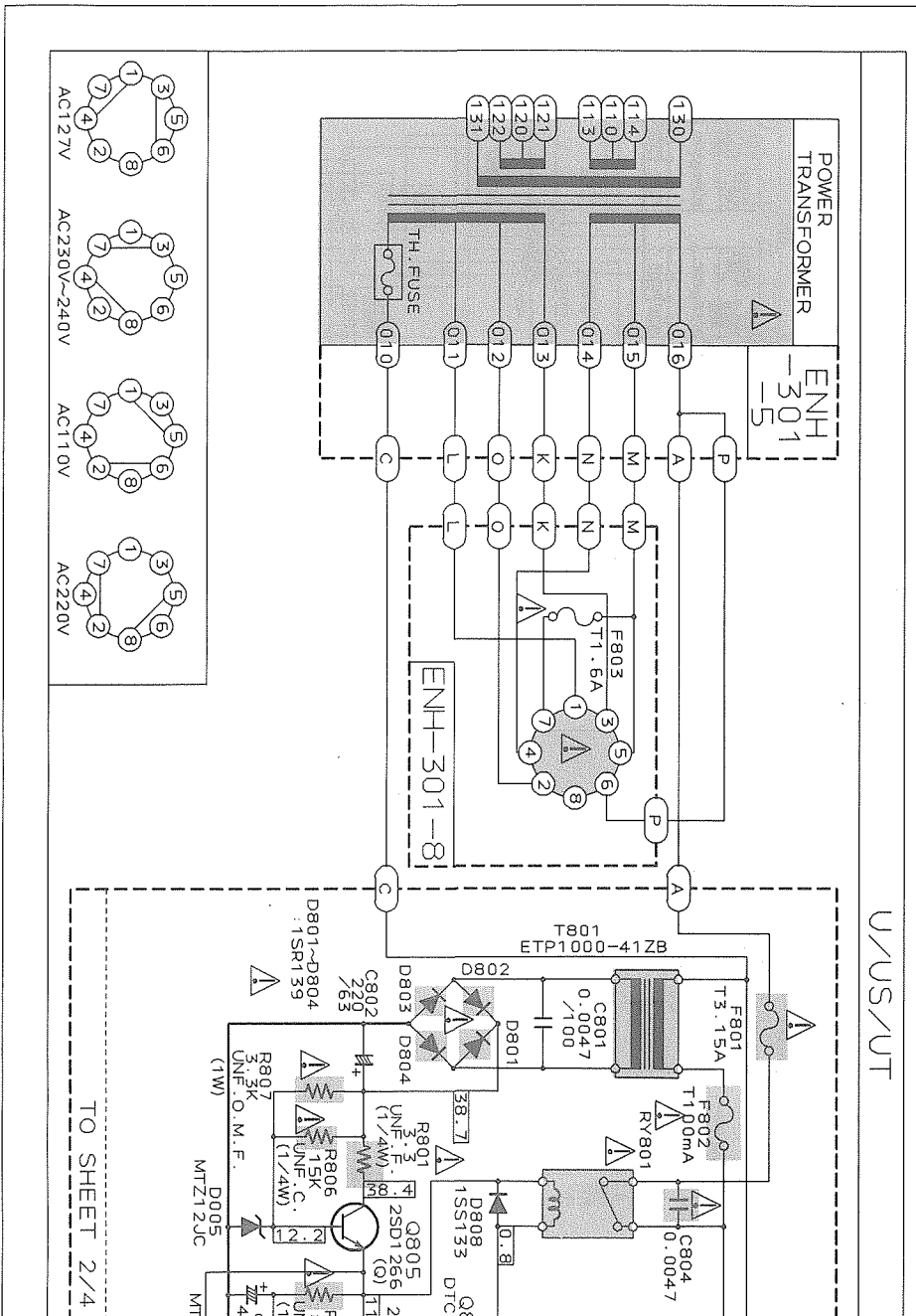

A

B

C

D



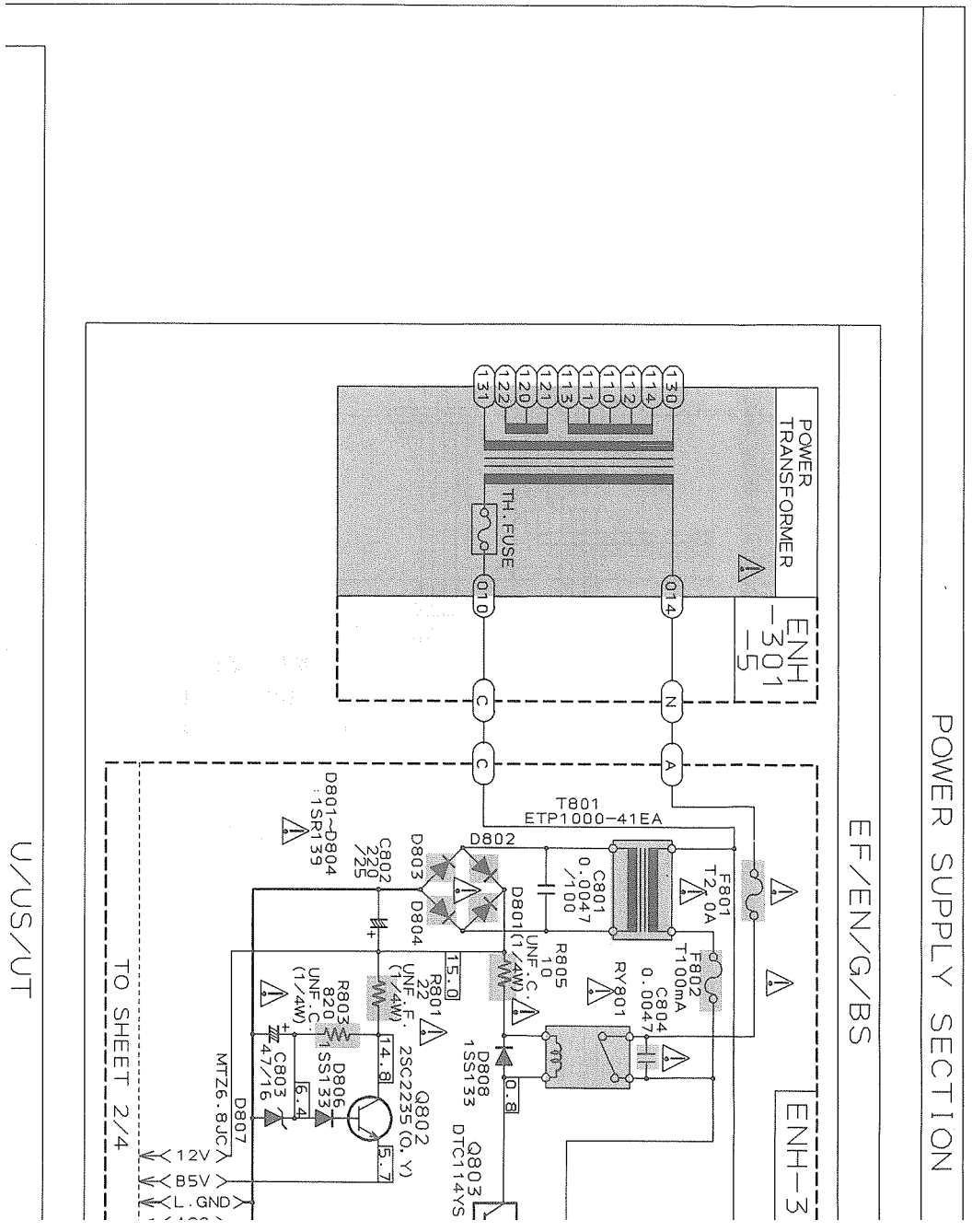

E

Schematic Diagrams POWER PRIMARY SECTION

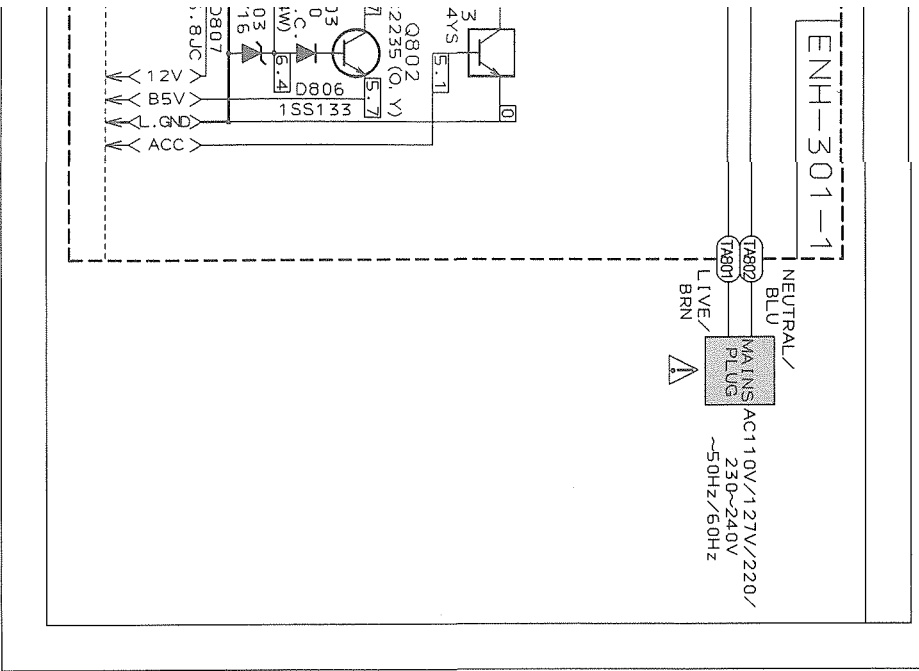

U/US/UT



- Notes:
1.  indicates Main signal path.
 2.  indicates REAR signal path.
 3.  indicates CENTER signal path.
 4. When replacing the parts in the darkened are () and those marked with  ,be sure to use the designated parts to ensure safety.
 5. This is the standard circuit diagram. The design and contents are subject to change without notice.

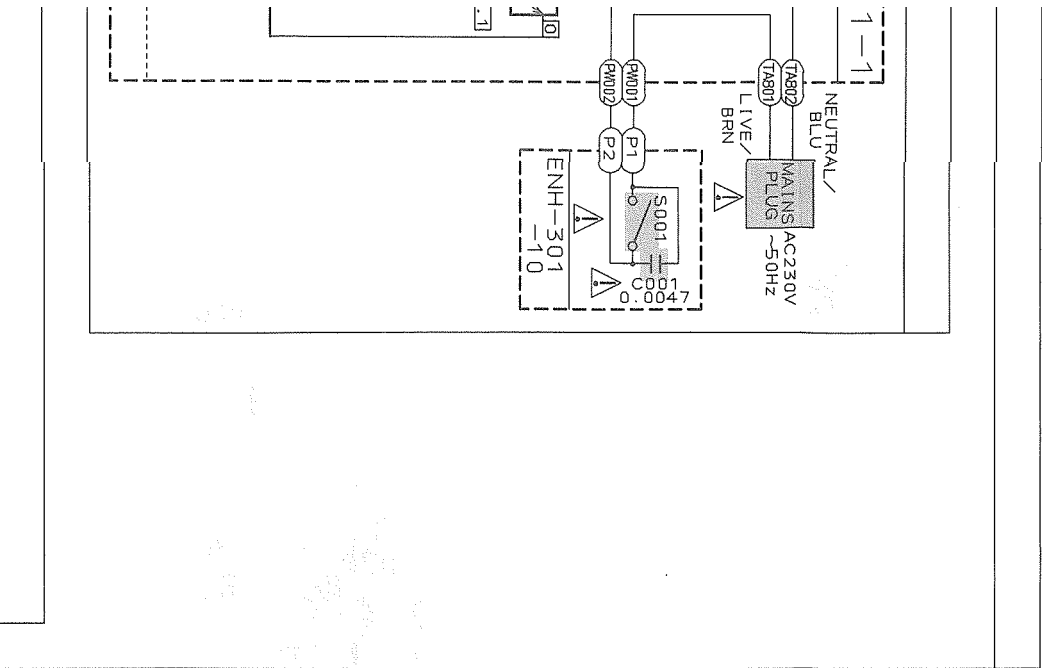

VERSION CODES

EN: NORDIC COUNTRIES
 EF: CONTINENTAL EUROPE EXCEPT GERMANY
 G : GERMANY
 BS: U.K.
 US: SINGAPORE
 UT: TAIWAN
 U : UNIVERSAL EXCEPT ALL OF ABOVE

NOTES:
 MARK (*) IS TO SHOW DEVIATION IN VERSIONS.
 DETAILS ARE EXPLAINED NEAR THE MARK.

EXPLANATION OF OVERALL OF SCHEMA.
 MODEL AX-V5BK

SHEET NUMBER	CIRCUITS DESCRIPTION
1/4	. PRIMARY
2/4	. RECTIFIER/REGULATOR /AUDIO AMP./SPEAKER TERMINAL
3/4	. AUDIO VIDEO SIGNAL INPUT TERMINAL /SURROUND IC./SOURCE SELECT IC. /FRONT REAR CENTER VOLUME
4/4	. USER CONTROL KEYS/SYSTEM CONTROL LSI /FL DISPLAY

2-18-a

2-18-b

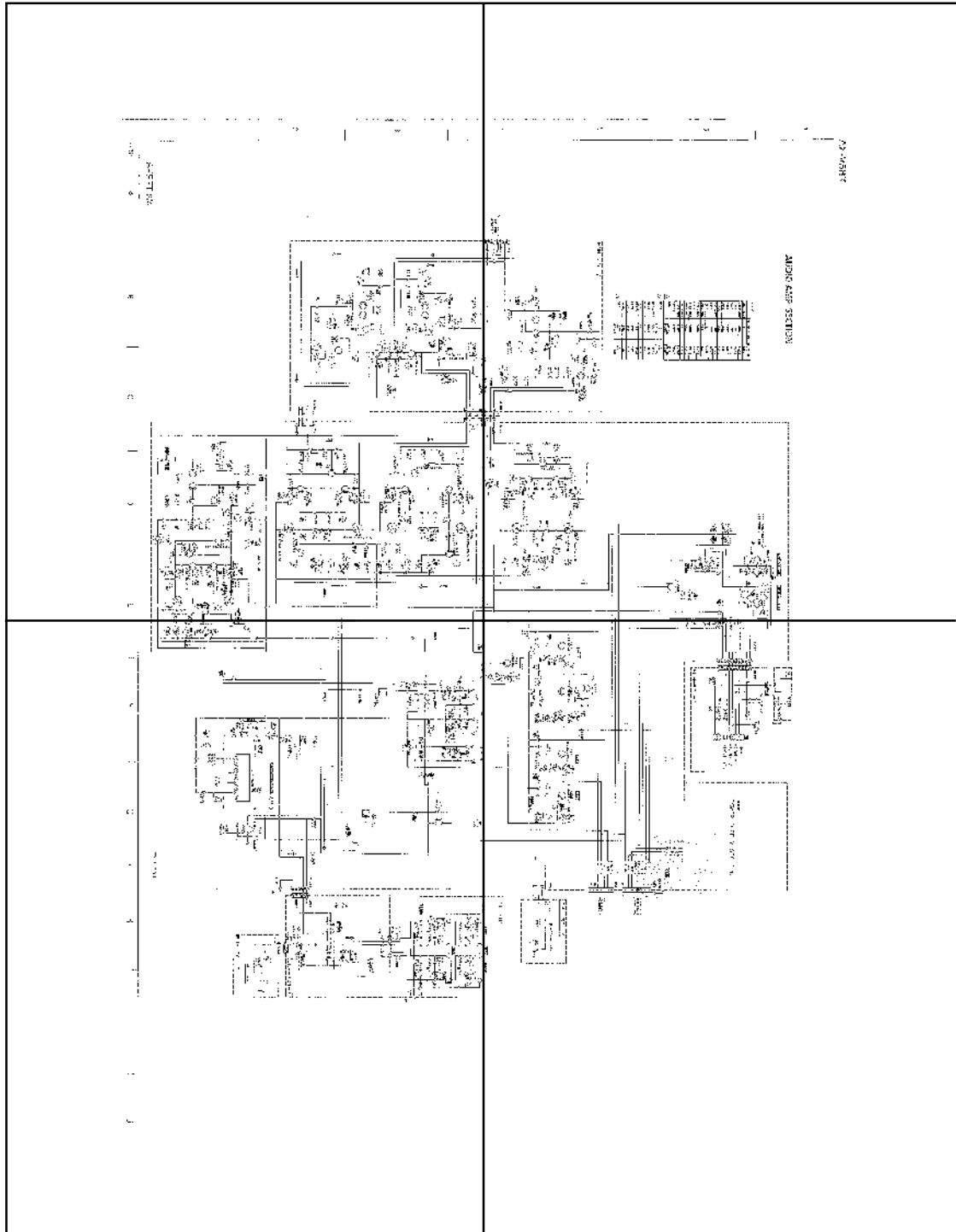

2-18-c

2-18-d

1

2

3

1

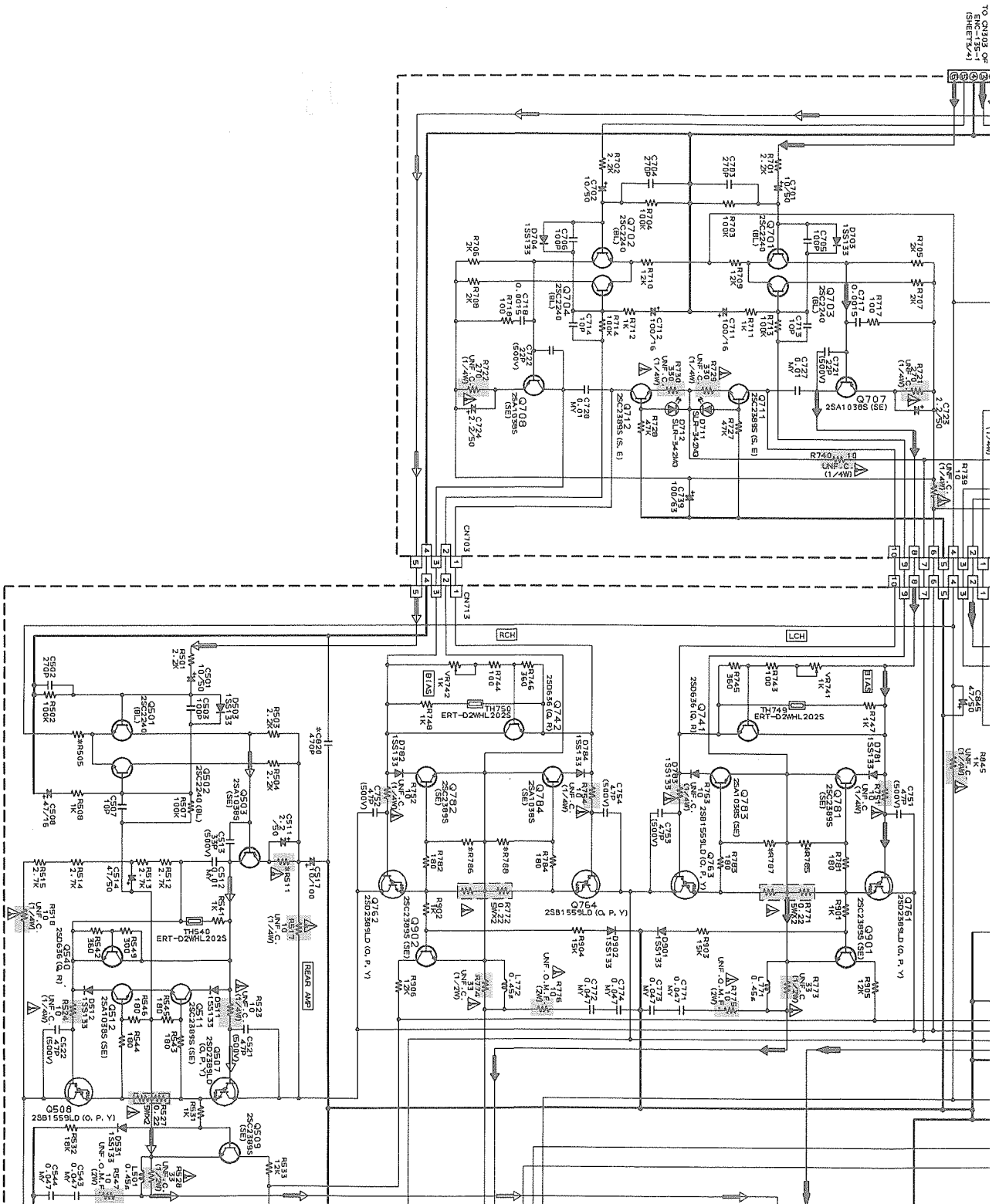

TO Q913 OF SHEET 3/4

1.1.1mm

R130 100 (1/4W)

R131 100 (1/4W)

R132 100 (1/4W)

R133 100 (1/4W)

R134 100 (1/4W)

R135 100 (1/4W)

R136 100 (1/4W)

R137 100 (1/4W)

R138 100 (1/4W)

R139 100 (1/4W)

R140 100 (1/4W)

R141 100 (1/4W)

R142 100 (1/4W)

R143 100 (1/4W)

R144 100 (1/4W)

R145 100 (1/4W)

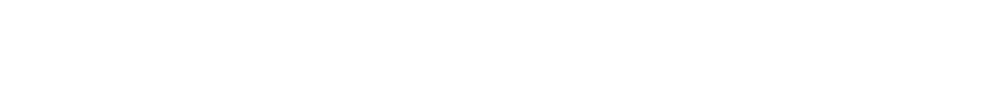
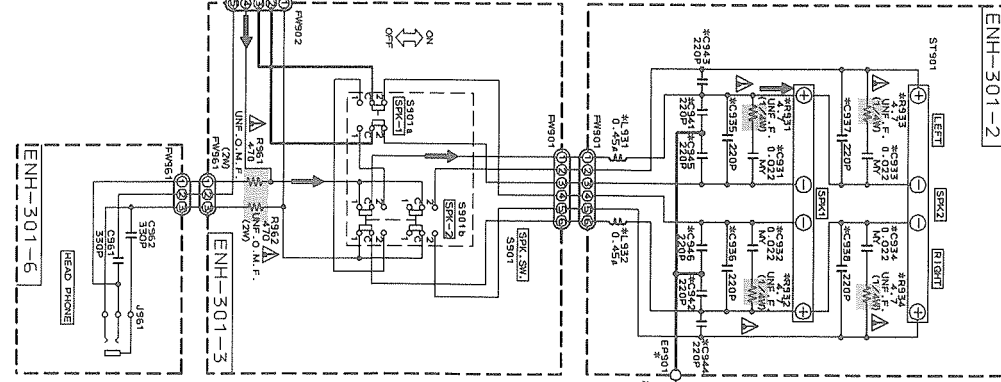
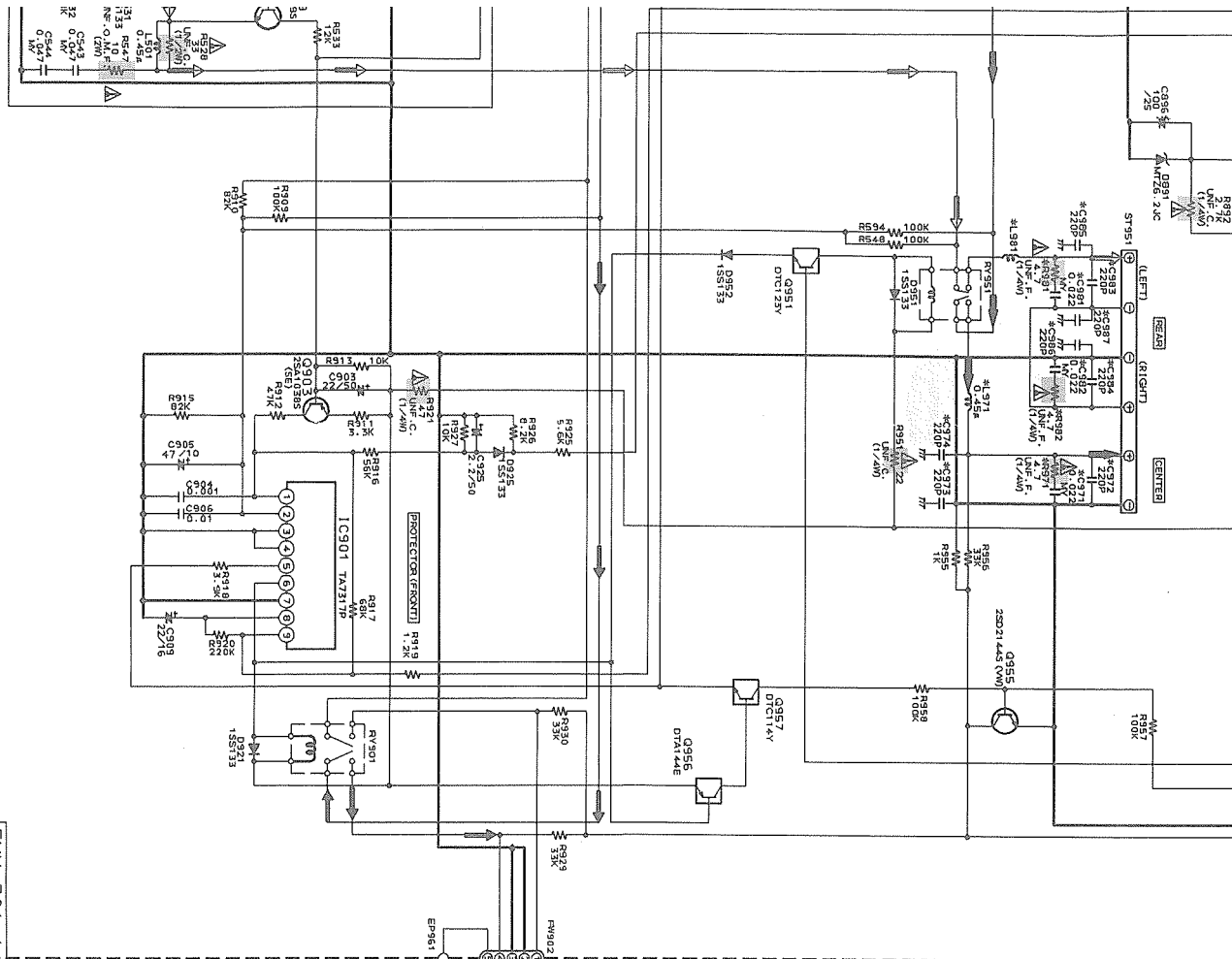

F G H I J

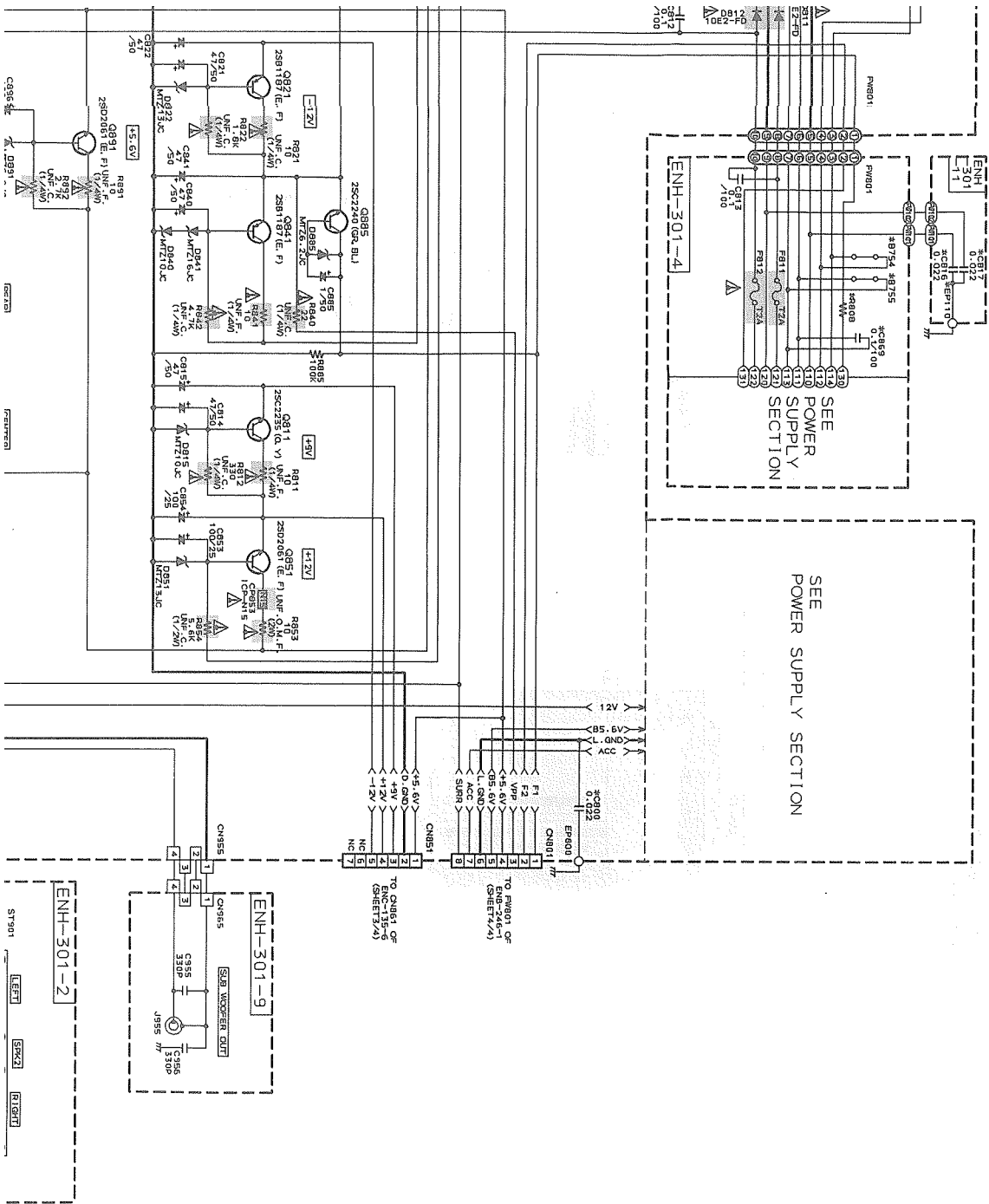

2-19-a

2-19-b

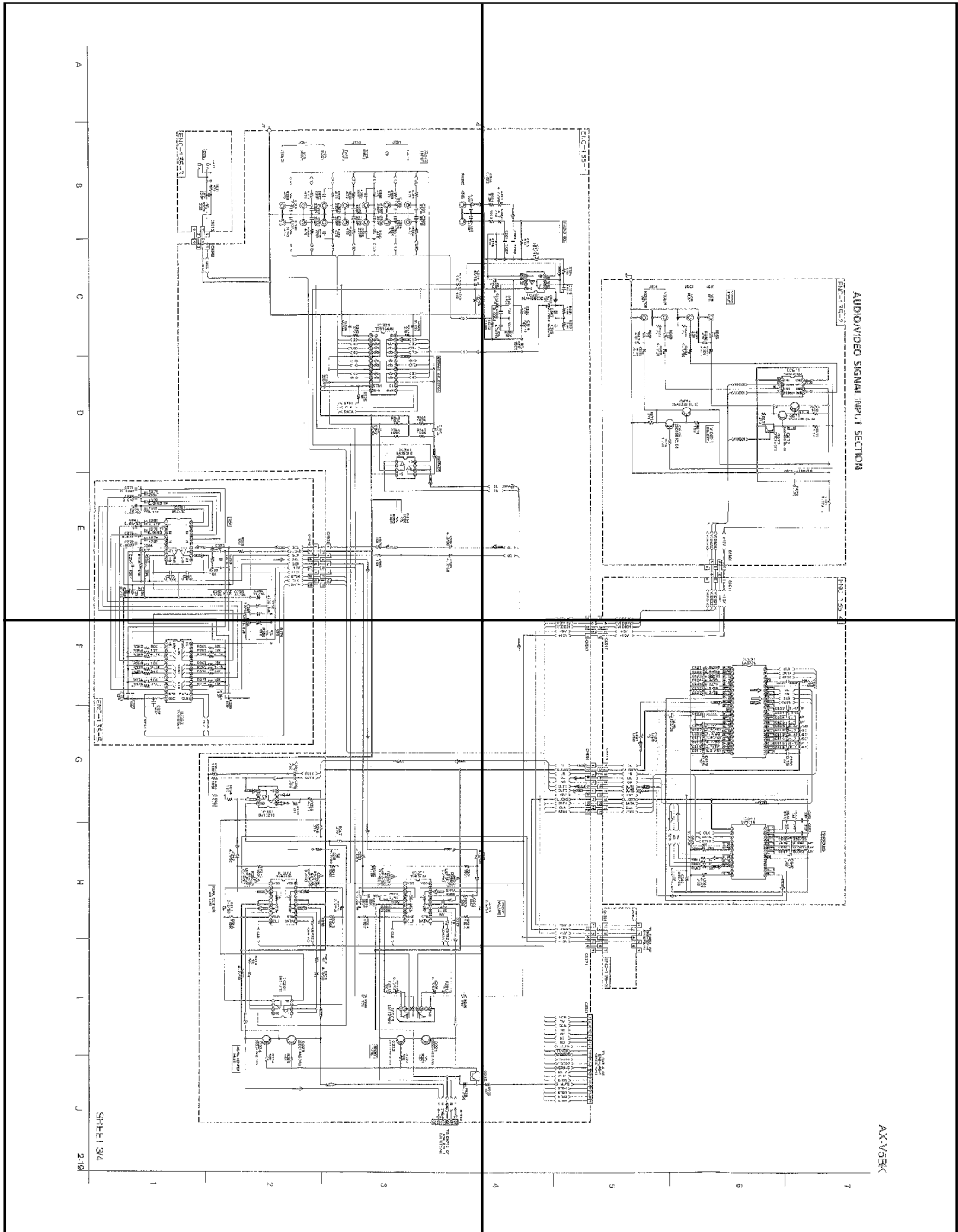

2-19-c

2-19-d

A

B

C

D

E

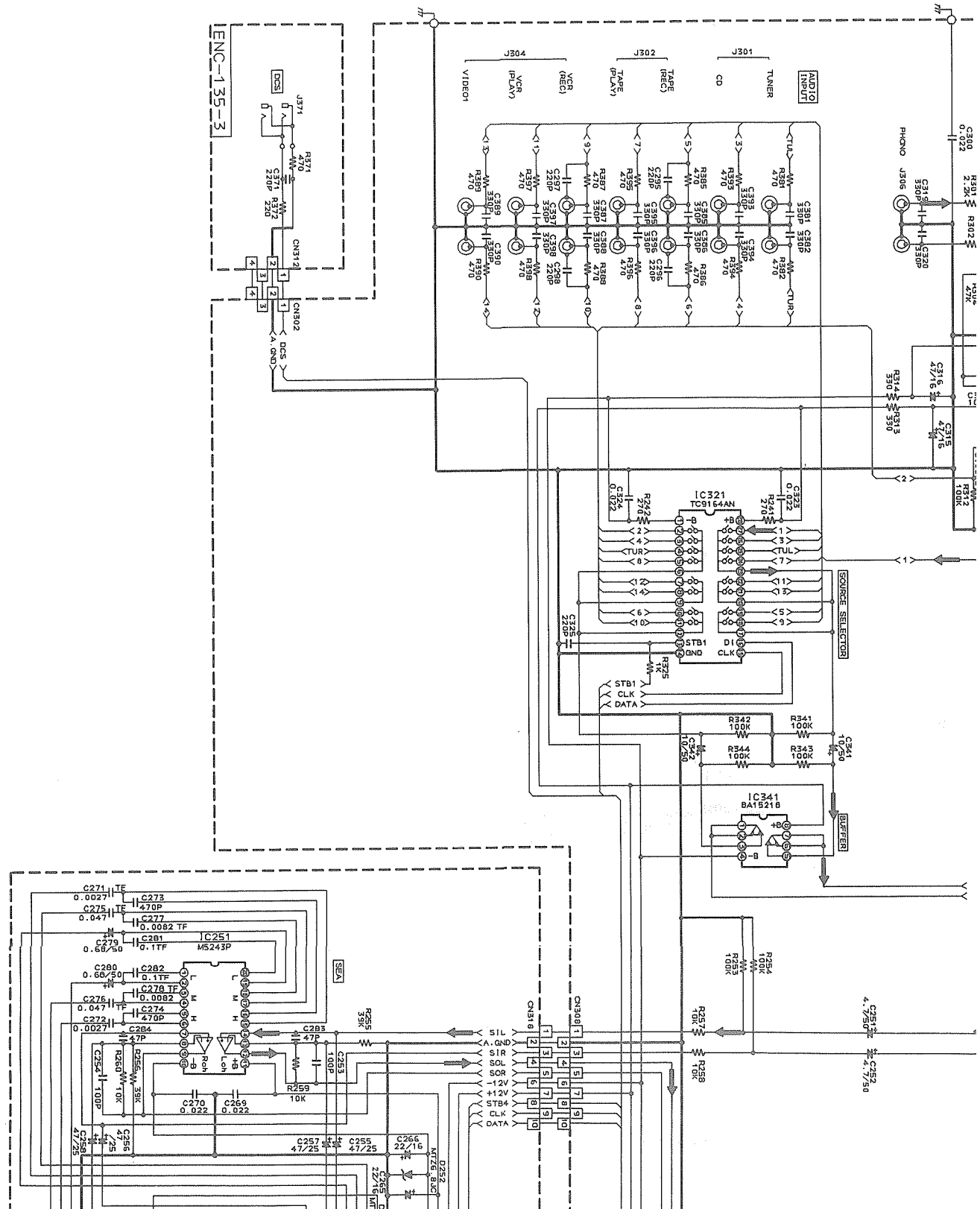

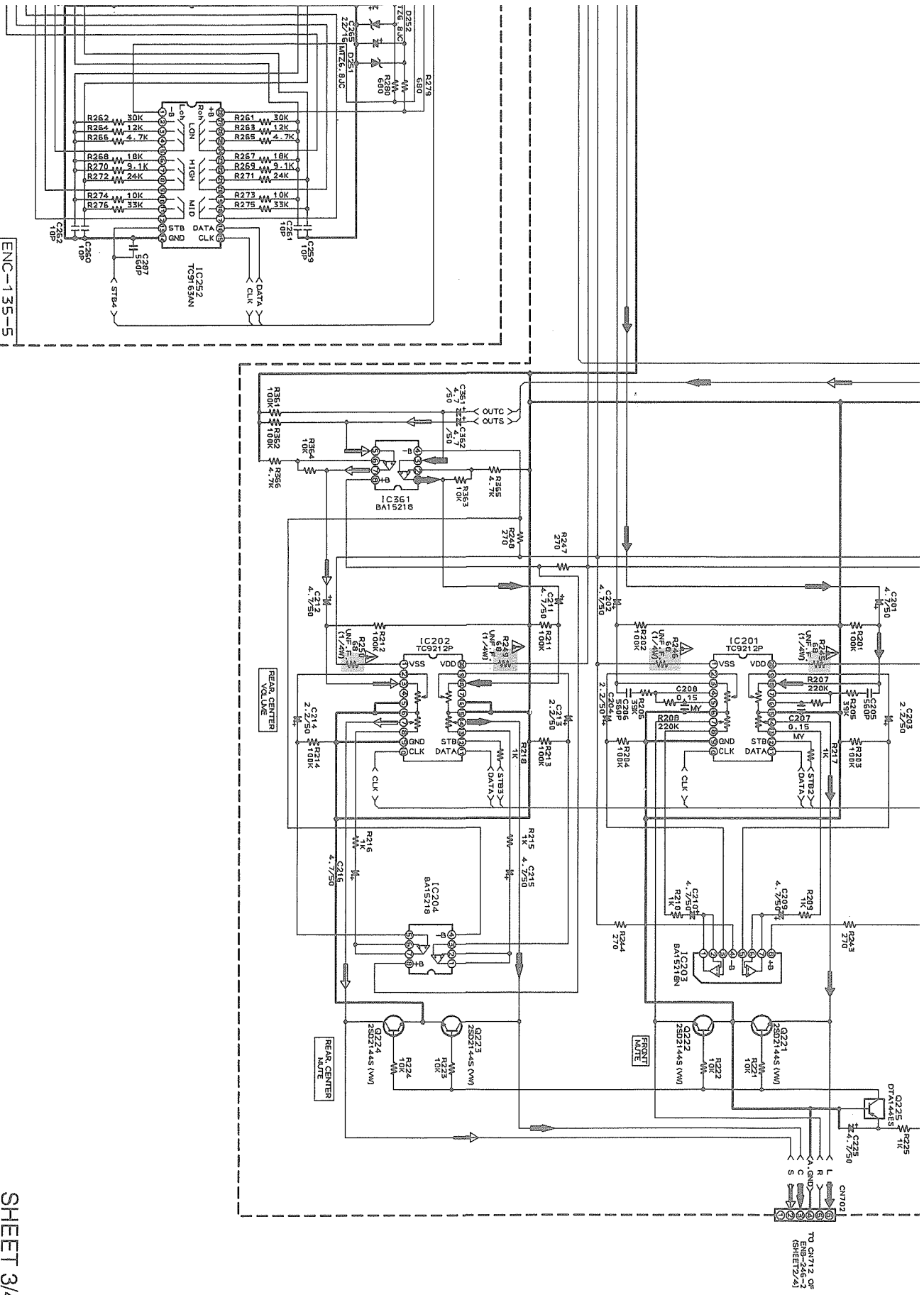

ENC-135-5

SHEET 3/4

F G H I J 2-19

1

2

3

4

135-4

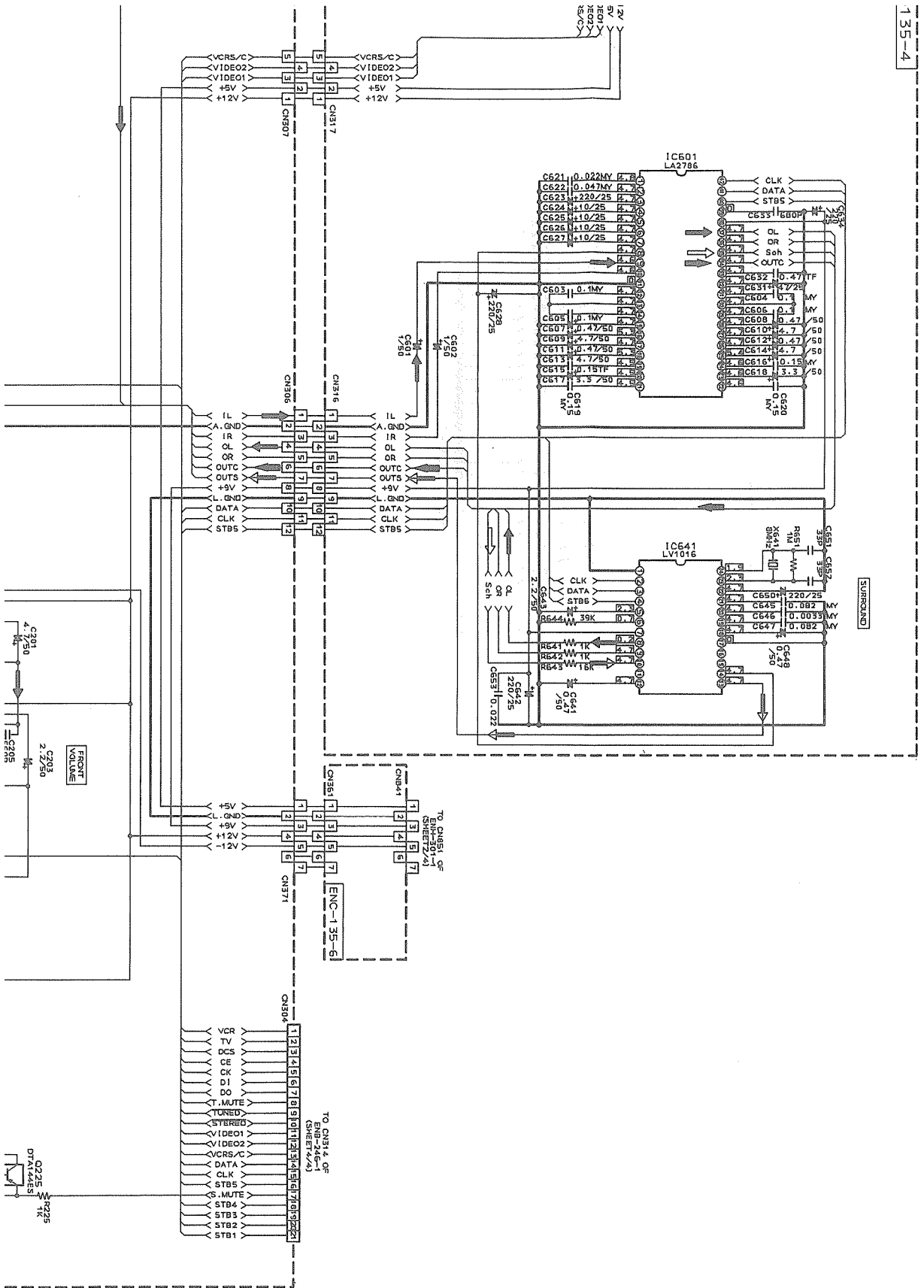

4

5

6

7

2-20-a

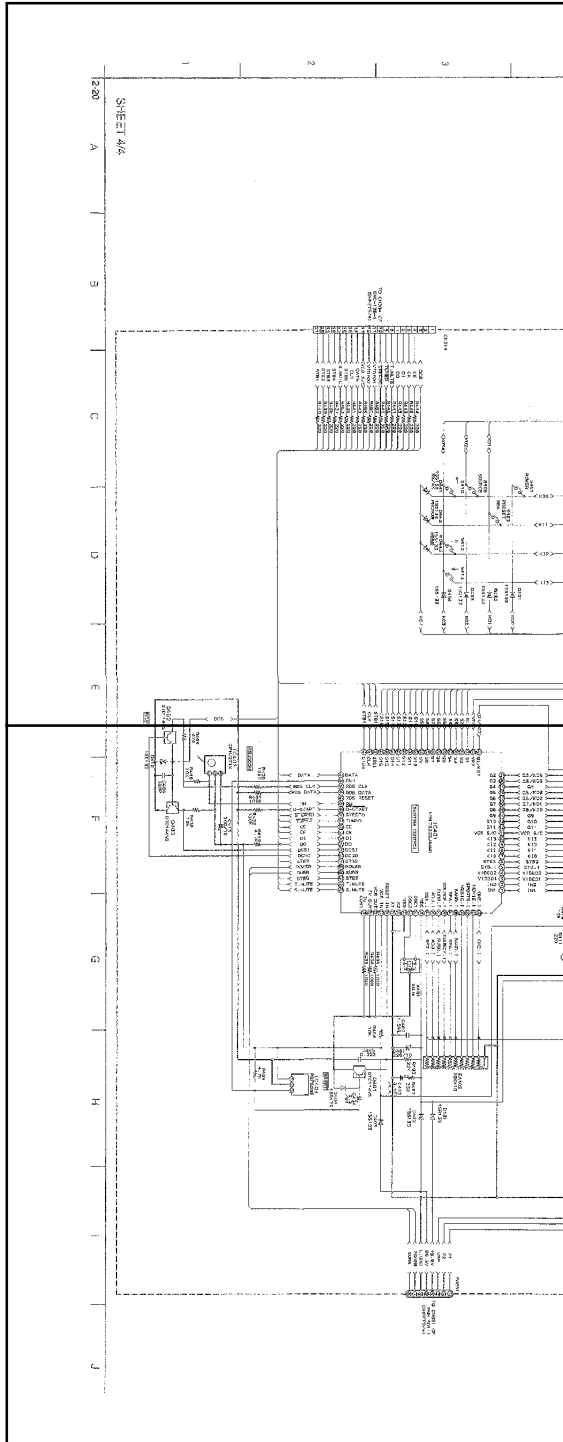

2-20-b

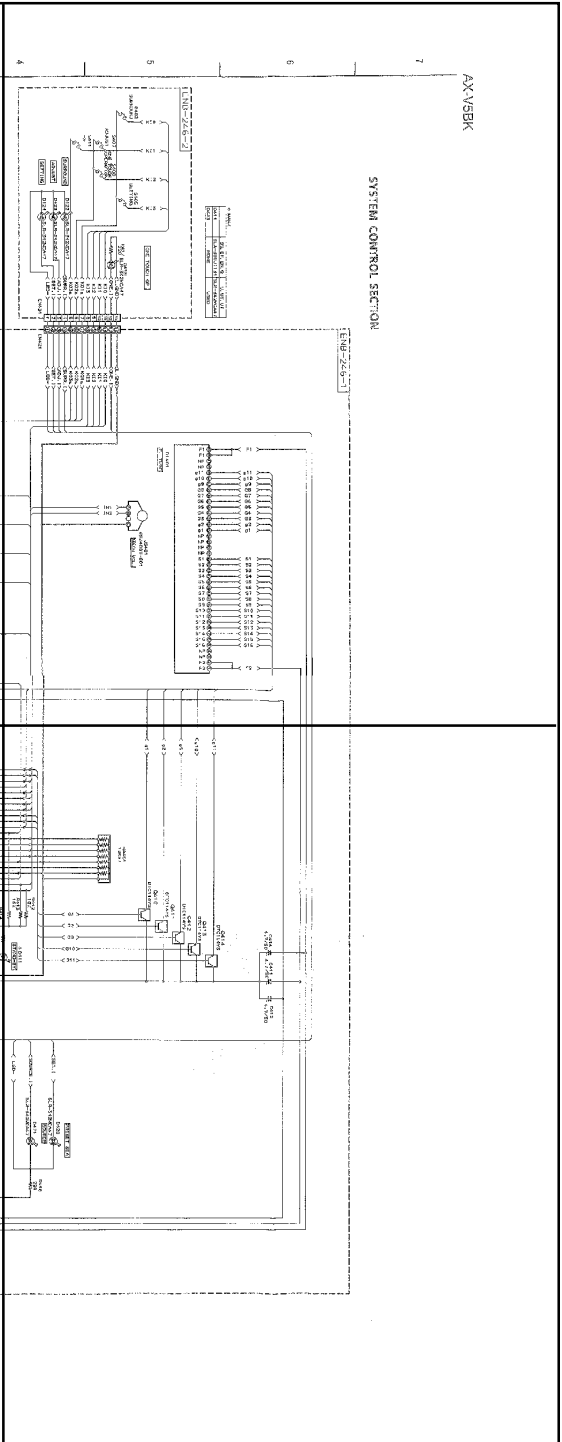

2-20-c



2-20-d



2-20

A

B

C

D

E

SHEET 4/4

1

2

3

TO CNS04 OF
ENC-135-1
(SHEETS/4)

1	<	DCS	>	R444	W-220
2	<	CE	>	R446	W-220
3	<	CK	>	R443	W-220
4	<	D1	>	R445	W-220
5	<	DO	>	R447	W-220
6	<	T.MUTE	>	R449	W-220
7	<	TUNED	>	R451	W-220
8	<	STEREO	>	R452	W-220
9	<	VIDEO1	>	R453	W-220
10	<	VIDEO2	>	R454	W-220
11	<	VCR S/C	>	R442	W-220
12	<	DATA	>	R441	W-220
13	<	CLK	>	R438	W-220
14	<	STB5	>	R437	W-220
15	<	S.MUTE	>	R437	W-220
16	<	STB4	>	R439	W-220
17	<	STB3	>	R439	W-220
18	<	STB2	>	R440	W-220
19	<	STB1	>	R440	W-220
20	<		>		
21	<		>		

CNS14

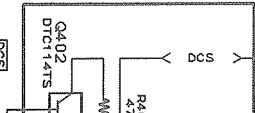
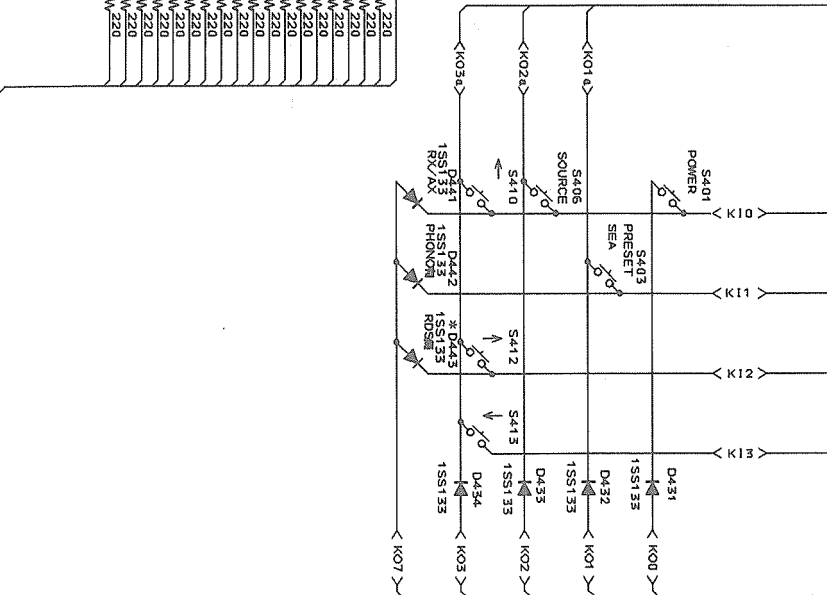

SYSTEM CONTROL SECTION

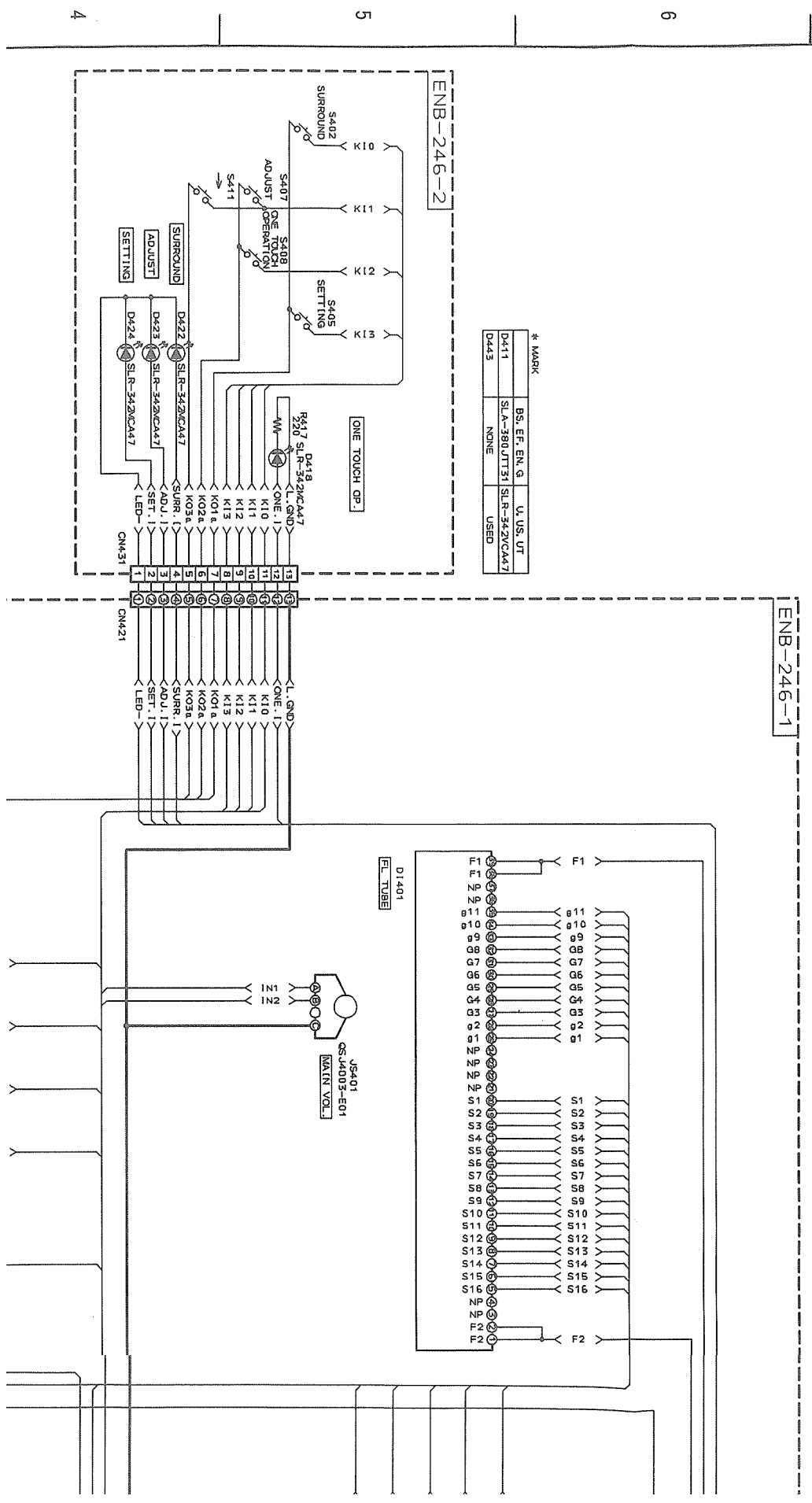

4

5

6

7

F G H I J

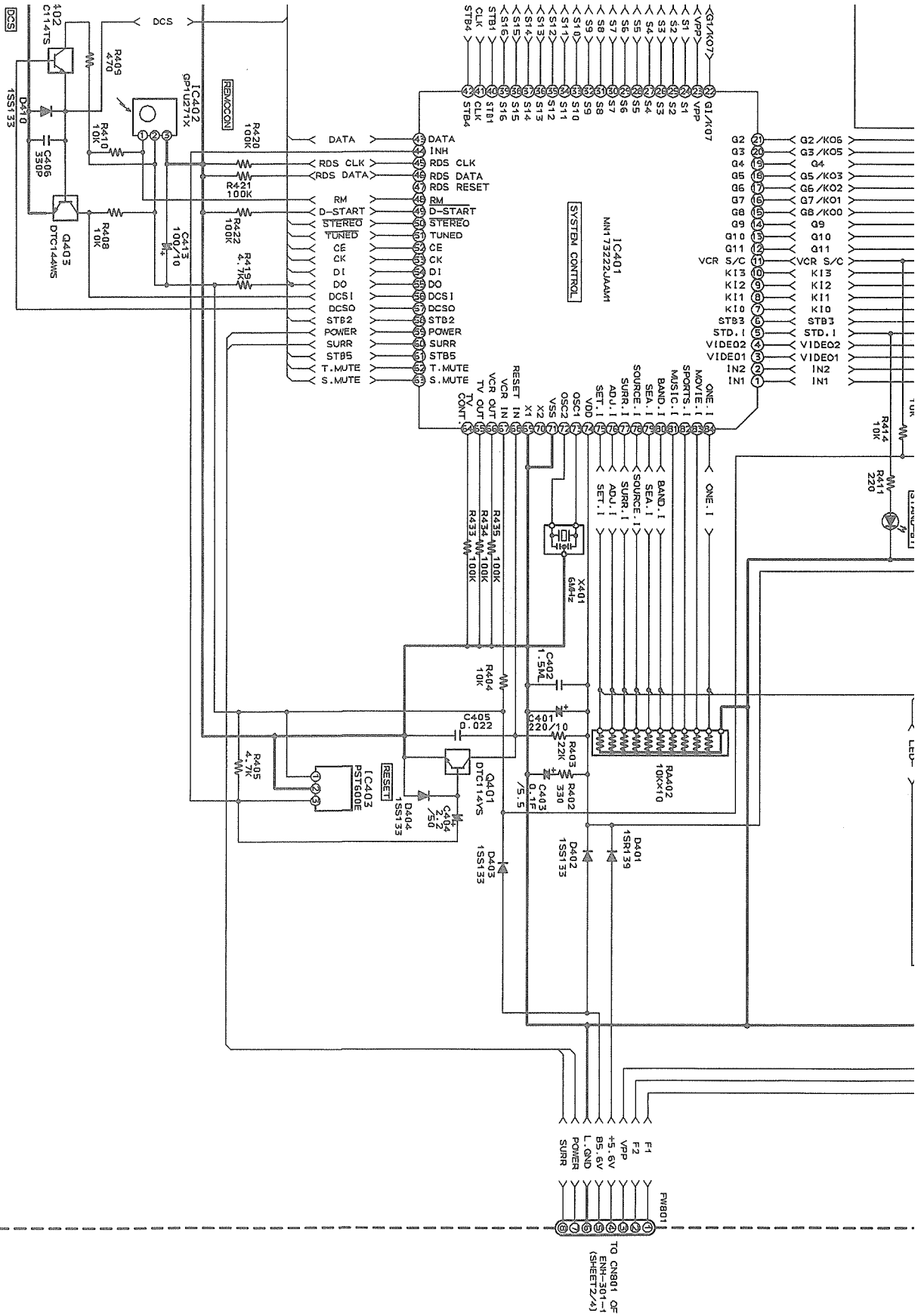

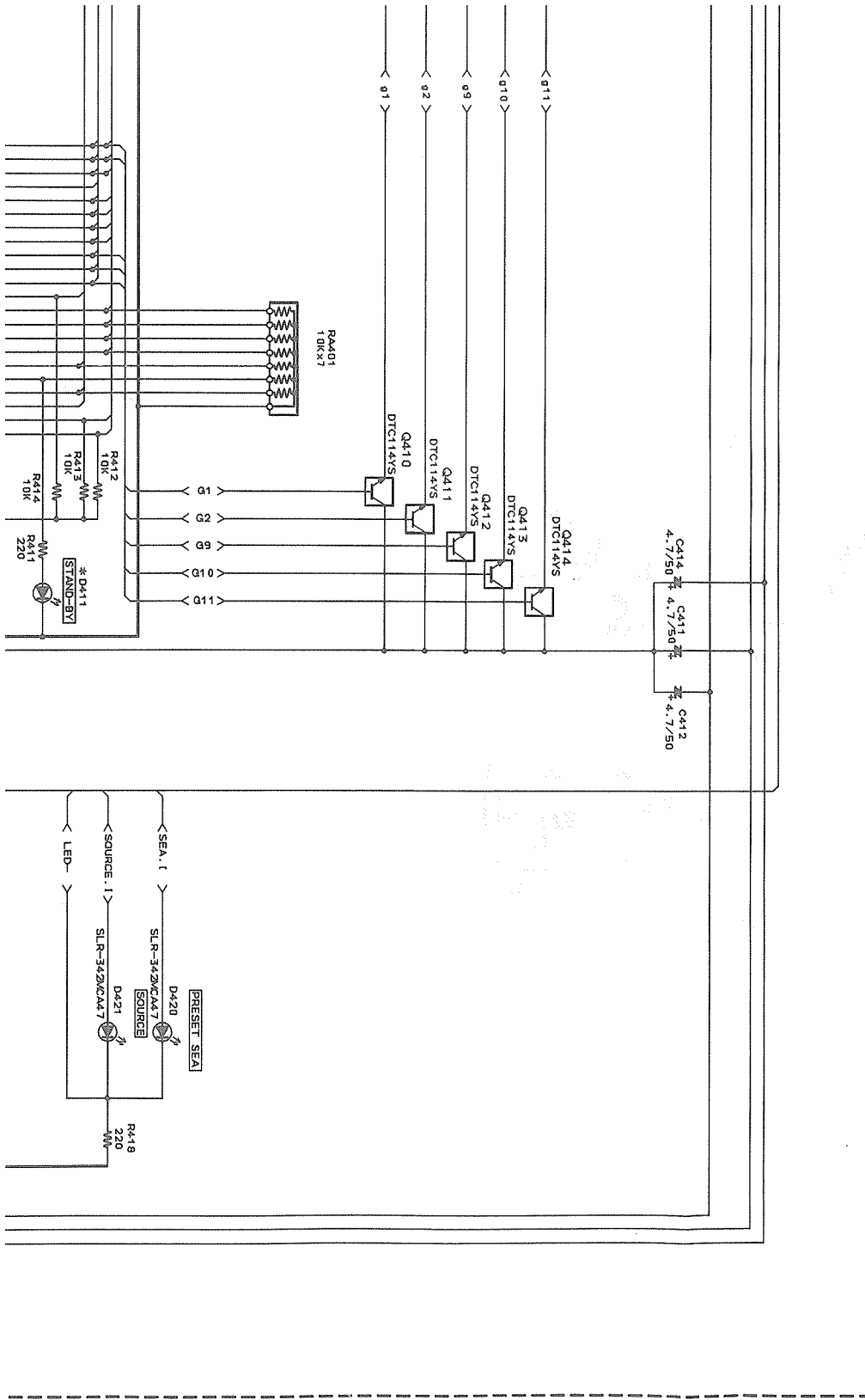

PARTS LIST

* All printed circuit boards and its assemblies are not available as service parts.

The Marks for Designated Areas	
BS ---	the U.K.
EF ---	Cntinental Europe Except Germany
EN ---	Nordic Countris
G ---	Germany
US ---	Singapore
UT ---	Taiwan
U ---	Universal Except All of Above
No marks indicates all areas.	

- Contents -

General Exploded View and Parts List	-----	3-2
Electrical Parts List	-----	3-4
(ENH-301)	-----	3-4
(ENB-246)	-----	3-9
(ENC-135)	-----	3-11
Accessories List	-----	3-14
Packing Materials and Parts List	-----	3-15

General Exploded View and Parts List

Block No. **M1M1**

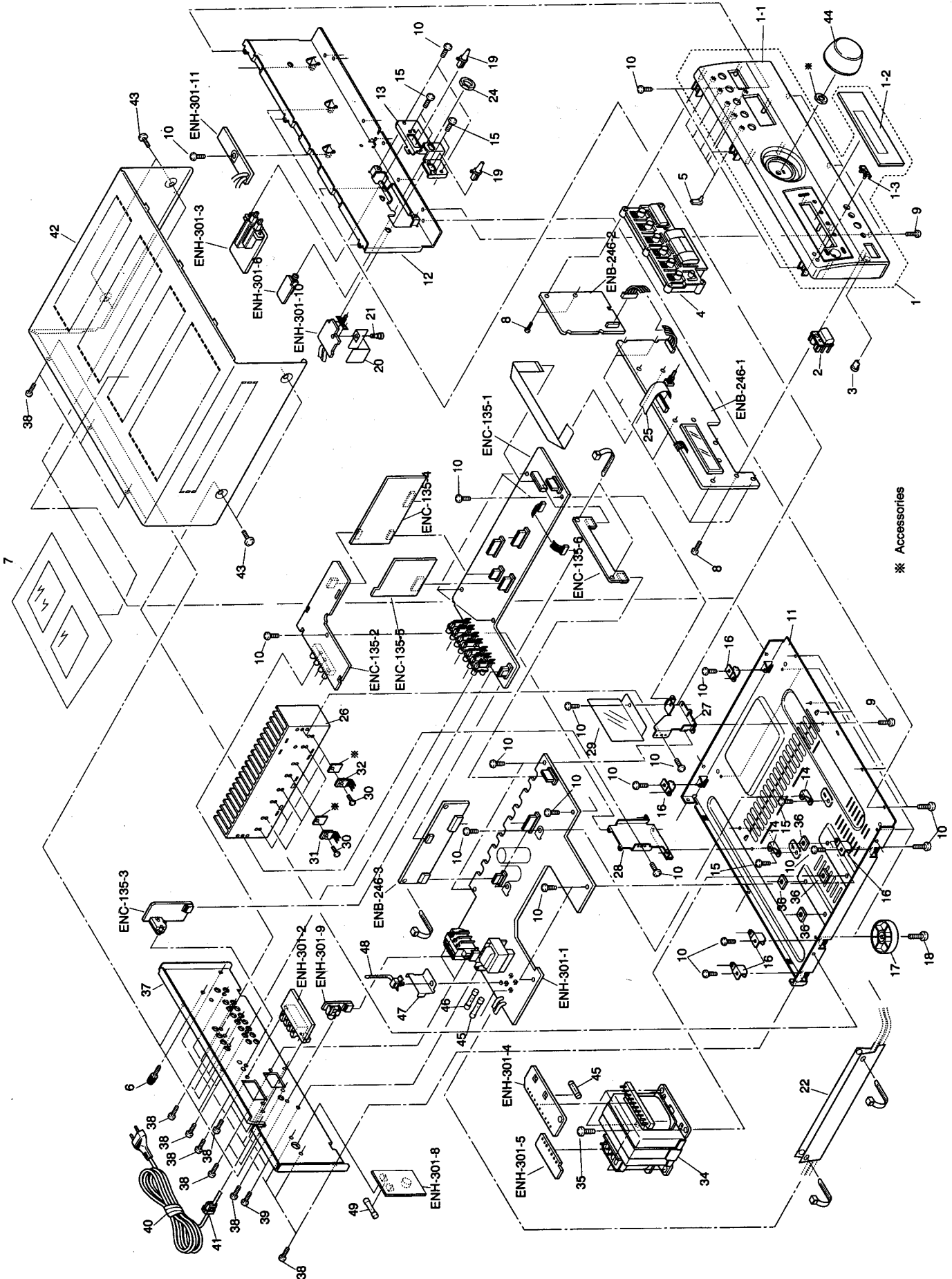

Parts List

Block No. **M1M1M1**

△	Item	Parts Number	Parts Name	Q'ty	Description	Area
	1	EFP-AXV5BKE (S)	FRONT PANEL ASS'Y	1		BS, EF, EN, G
	1	EFP-AXV5BKU (S)	FRONT PANEL ASS'Y	1		U, US, UT
	1-1	LE10079-009A	FRONT PANEL	1		BS, EF, EN, G
	1-1	LE10079-010A	FRONT PANEL	1		U, US, UT
	1-2	LE30361-002A	WINDOW SCREEN	1		
	1-3	VJD5429-001	JVC MARK	1		
	2	LE30359-001A	POWER BUTTON	1		BS, EF, EN, G
	2	LE30359-002A	POWER BUTTON	1		U, US, UT
	3	FSJD4001-002	INDICATOR LENS	1	POWER	
	4	LE20125-002A	PUSH BUTTON	1		
	5	LE40137-001A	INDICATOR LENS	6	SOURCE	
	6	E409257-001	EARTH TERMINAL	1		
	7	E208294-001SM	PROTECT SHEET	1	METAL COVER	U, US, UT
	8	SDSF2608Z	SCREW	11		
	9	SDSG3008M	TAPPING SCREW	6		
	10	SBSG3008CC	TAPPING SCREW	29		
	10	SBSG3008CC	TAPPING SCREW	1		BS, EF, EN, G
	11	LE10081-001A	CHASSIS BASE	1		
	12	LE20126-002A	FRONT BRACKET	1		
	13	LE30365-003A	BRACKET	1		
	14	E68587-223SM	P. W. BOARD BRACKET	2		
	15	SBST3006CC	TAPPING SCREW	4		
	15	SBST3006CC	TAPPING SCREW	2		BS, EF, EN, G
	16	LE40138-001A	GUIDE BRACKET	5		
	17	VJF4039-00MSM	FOOT ASSY	4		
	18	SBST3010Z	TAPPING SCREW	4		
	19	E407321-002SM	PUSH BUTTON	2	SPKER	
	19	E407321-002SM	PUSH BUTTON	1	POWER	BS, EF, EN, G
	20	LE40264-001A	PROTECTOR COVER	1		BS, EF, EN, G
	21	E310243-002	PLASTIC RIVET	1		BS, EF, EN, G
	22	LE40175-202A	PROTECTOR COVER	1		BS, EF, EN, G
△	23	QMF51E2-1R6J1	FUSE	1	F803	U, US, UT
	24	VKZ4150-001	NUT	1		
	25	VWF1221-30TTB	FLAT WIRE	1	FW304	
	26	E309840-005SM	HEAT SINK	1		
	27	E310171-001SM	HEAT SINK BRACKET	1	FRONT SIDE	
	28	E310172-001SM	HEAT SINK BRACKET	1	REAR SIDE	
	29	LE40263-001A	PROTECTOR COVER	1		
	30	E73525-003	SCREW	8		
	31	2SD2389LD/OPY/	SI. TRANSISTOR	4	Q761, Q762, Q507, Q575	
	32	2SB1559LD/OPY/	SI. TRANSISTOR	4	Q763, Q764, Q508, Q576	
	33	E409396-001	CAUTION LABEL	1		
△	34	QQT0163-001	POWER TRANSFORMER	1		U, US, UT
△	34	QQT0164-003	POWER TRANSFORMER	1		BS, EF, EN, G
	35	E65389-006	SPECIAL SCREW	4		
	36	E406309-002	SPACER	4		
	37	LE20127-004A	REAR PANEL	1		BS, EF, EN, G
	37	LE20127-007A	REAR PANEL	1		U, US, UT
	38	E73273-006	SPECIAL SCREW	19		
	38	E73273-006	SPECIAL SCREW	2		U, US, UT
	39	SBST3006M	TAPPING SCREW	1		
	39	SBST3006M	TAPPING SCREW	1		BS, EF, EN, G
△	40	QMP39E0-200	POWER CORD	1		EF, EN, G, US
△	40	QMP5530-0085BS	POWER CORD	1		BS
△	40	QMP7520-200	POWER CORD	1		U, UT
△	41	QHS3771-108	CORD STOPPER	1		EF, EN, G, U, US, UT
△	41	QHS3771-108BS	CORD STOPPER	1		BS
	42	LE20131-001A (S)	METAL COVER	1		BS, EF, EN, G
	42	LE20131-002A (S)	METAL COVER	1		U, US, UT
	43	E406308-003	SPECIAL SCREW	4		
	44	E309823-001SM	VOLUME KNOB	1		
△	45	QMF51E2-2R0	FUSE	2	F811, F812	
△	45	QMF51E2-2R0	FUSE	1	F801	BS, EF, EN, G
△	45	QMF51E2-3R15J1	FUSE	1	F801	U, US, UT
△	46	QMF51A2-R10S	FUSE	1	F802	
	47	LE40217-001A	PROTECTOR COVER	1		BS, EF, EN, G
	48	E307572-001	VINYL TIE	1		BS, EF, EN, G

AX-V5BK

Electrical Parts List (ENH-301)

Item	Parts Number	Description	Area
	I. C. S		
IC901	TA7317P	I. C (MONO-ANALOG)	
	DIODES		
D503	1SS133	SI. DIODE	
D511	1SS133	SI. DIODE	
D512	1SS133	SI. DIODE	
D531	1SS133	SI. DIODE	
D585	1SS133	SI. DIODE	
D586	1SS133	SI. DIODE	
D591	1SS133	SI. DIODE	
D781	1SS133	SI. DIODE	
D782	1SS133	SI. DIODE	
D783	1SS133	SI. DIODE	
D784	1SS133	SI. DIODE	
D801	1SR139-200	SI. DIODE	
D802	1SR139-200	SI. DIODE	
D803	1SR139-200	SI. DIODE	
D804	1SR139-200	SI. DIODE	
D805	MTZ12JC	ZENER DIODE	U
D805	MTZ12JC	ZENER DIODE	US
D805	MTZ12JC	ZENER DIODE	UT
D806	1SS133	SI. DIODE	
D807	MTZ6.8JC	ZENER DIODE	
D808	1SS133	SI. DIODE	
D811	10E2-FD	DIODE	
D812	10E2-FD	DIODE	
D815	MTZ10JC	ZENER DIODE	
D822	MTZ13JC	ZENER DIODE	
D840	MTZ10JC	ZENER DIODE	
D841	MTZ16JC	ZENER DIODE	
D851	MTZ13JC	ZENER DIODE	
D860	1SS133	SI. DIODE	BS
D860	1SS133	SI. DIODE	EF
D860	1SS133	SI. DIODE	EN
D860	1SS133	SI. DIODE	G
D861	30DF2SFC	SI. DIODE	
D862	30DF2SFC	SI. DIODE	
D863	30DF2SFC	SI. DIODE	
D864	30DF2SFC	SI. DIODE	
D865	30DF2SFC	SI. DIODE	BS
D865	30DF2SFC	SI. DIODE	EF
D865	30DF2SFC	SI. DIODE	EN
D865	30DF2SFC	SI. DIODE	G
D866	30DF2SFC	SI. DIODE	BS
D866	30DF2SFC	SI. DIODE	EF
D866	30DF2SFC	SI. DIODE	EN
D866	30DF2SFC	SI. DIODE	G
D867	30DF2SFC	SI. DIODE	BS
D867	30DF2SFC	SI. DIODE	EF
D867	30DF2SFC	SI. DIODE	EN
D867	30DF2SFC	SI. DIODE	G
D868	30DF2SFC	SI. DIODE	BS
D868	30DF2SFC	SI. DIODE	EF
D868	30DF2SFC	SI. DIODE	EN
D868	30DF2SFC	SI. DIODE	G
D885	MTZ6.2JC	ZENER DIODE	
D891	MTZ6.2JC	ZENER DIODE	
D901	1SS133	SI. DIODE	
D902	1SS133	SI. DIODE	
D921	1SS133	SI. DIODE	
D925	1SS133	SI. DIODE	
D951	1SS133	SI. DIODE	
D952	1SS133	SI. DIODE	
	TRANSISTORS		
Q501	2SC2240 (BL)	SI. TRANSISTOR	
Q502	2SC2240 (BL)	SI. TRANSISTOR	
Q503	2SA1038 (R, S)	SI. TRANSISTOR	
Q509	2SC2389 (S, E)	SI. TRANSISTOR	
Q511	2SC2389 (S, E)	SI. TRANSISTOR	

Item	Parts Number	Description	Area
Q512	2SA1038 (R, S)	SI. TRANSISTOR	
Q540	2SD636	SI. TRANSISTOR	
Q568	2SD636	SI. TRANSISTOR	
Q585	2SC2389 (S, E)	SI. TRANSISTOR	
Q586	2SA1038 (R, S)	SI. TRANSISTOR	
Q591	2SC2389 (S, E)	SI. TRANSISTOR	
Q741	2SD636	SI. TRANSISTOR	
Q742	2SD636	SI. TRANSISTOR	
Q781	2SC2389 (S, E)	SI. TRANSISTOR	
Q782	2SC2389 (S, E)	SI. TRANSISTOR	
Q783	2SA1038 (R, S)	SI. TRANSISTOR	
Q784	2SA1038 (R, S)	SI. TRANSISTOR	
Q802	2SC2235 (O, Y)	SI. TRANSISTOR	
Q803	DTC114ES	DIGITAL TRANSISTOR	
Q805	2SD1266	SI. TRANSISTOR	U
Q805	2SD1266	SI. TRANSISTOR	US
Q805	2SD1266	SI. TRANSISTOR	UT
Q811	2SC2235 (O, Y)	SI. TRANSISTOR	
Q821	2SB1187 (F, G)	SI. TRANSISTOR	
Q841	2SB1187 (F, G)	SI. TRANSISTOR	
Q851	2SD2061 (F, G)	SI. TRANSISTOR	
Q860	DTC123YS	DIGITAL TRANSISTOR	BS
Q860	DTC123YS	DIGITAL TRANSISTOR	EF
Q860	DTC123YS	DIGITAL TRANSISTOR	EN
Q860	DTC123YS	DIGITAL TRANSISTOR	G
Q885	2SC2240 (GR, BL)	SI. TRANSISTOR	
Q891	2SD2061 (F, G)	SI. TRANSISTOR	
Q901	2SC2389 (S, E)	SI. TRANSISTOR	
Q902	2SC2389 (S, E)	SI. TRANSISTOR	
Q903	2SA1038 (R, S)	SI. TRANSISTOR	
Q951	DTC123YS	DIGITAL TRANSISTOR	
Q955	2SD2144S (VW)	SI. TRANSISTOR	
Q956	DTA144ES	DIGITAL TRANSISTOR	
Q957	DTC114YS	DIGITAL TRANSISTOR	
	CAPACITORS		
C001	QCZ9019-472	4700PF C. CAP.	BS
C001	QCZ9019-472	4700PF C. CAP.	EF
C001	QCZ9019-472	4700PF C. CAP.	EN
C001	QCZ9019-472	4700PF C. CAP.	G
C501	QETB1HM-106	10MF 50V E. CAP.	
C502	QCS21HJ-271A	270PF 50V CER. CAP.	
C503	QCS21HJ-101A	100PF 50V CER. CAP.	
C507	QCS21HJ-100	10PF 50V CER. CAP.	
C508	QETB1CM-476	47MF 16V AL E. CAP.	
C511	QETB1HM-225	2.2MF 50V AL E. CAP.	
C512	QFLB1HJ-103	0.01MF 50V MYLAR CAP.	
C513	QCS22HJ-330	33PF 500V CER. CAP.	
C514	QETB1HM-476	47MF 50V E. CAP.	
C517	QETB2AM-106	10MF 100V AL E. CAP.	
C521	QCS22HJ-470A	47PF 500V CER. CAP.	
C522	QCS22HJ-470A	47PF 500V CER. CAP.	
C543	QFLB1HJ-473	0.047MF 50V MYLAR CAP.	
C544	QFLB1HJ-473	0.047MF 50V MYLAR CAP.	
C571	QCS22HJ-470A	47PF 500V CER. CAP.	
C572	QCS22HJ-470A	47PF 500V CER. CAP.	
C581	QFLB1HJ-473	0.047MF 50V MYLAR CAP.	
C582	QFLB1HJ-473	0.047MF 50V MYLAR CAP.	
C751	QCS22HJ-470A	47PF 500V CER. CAP.	
C752	QCS22HJ-470A	47PF 500V CER. CAP.	
C753	QCS22HJ-470A	47PF 500V CER. CAP.	
C754	QCS22HJ-470A	47PF 500V CER. CAP.	
C771	QFLB1HJ-473	0.047MF 50V MYLAR CAP.	
C772	QFLB1HJ-473	0.047MF 50V MYLAR CAP.	
C773	QFLB1HJ-473	0.047MF 50V MYLAR CAP.	
C774	QFLB1HJ-473	0.047MF 50V MYLAR CAP.	
C800	QCHB1EZ-223	0.022MF 25V CER. CAP.	BS
C800	QCHB1EZ-223	0.022MF 25V CER. CAP.	EF
C800	QCHB1EZ-223	0.022MF 25V CER. CAP.	EN
C800	QCHB1EZ-223	0.022MF 25V CER. CAP.	G

Electrical Parts List (ENH-301)

△	Item	Parts Number	Description	Area
	C801	QFN82AK-472	4700PF 100V METAL. MYLAR	
	C802	QETB1JM-227	220MF 63V AL E. CAP.	U
	C802	QETB1JM-227	220MF 63V AL E. CAP.	US
	C802	QETB1JM-227	220MF 63V AL E. CAP.	UT
	C802	QETC1EM-227ZN	220MF 25V AL E. CAP.	BS
	C802	QETC1EM-227ZN	220MF 25V AL E. CAP.	EF
	C802	QETC1EM-227ZN	220MF 25V AL E. CAP.	EN
	C802	QETC1EM-227ZN	220MF 25V AL E. CAP.	G
	C803	QETB1CM-476	47MF 16V AL E. CAP.	
△	C804	QCZ9019-472	4700PF C. CAP.	
	C811	QETB1VM-228N	2200MF 35V E. CAP.	
	C812	QFN82AJ-104	0.1MF 100V MYLAR CAP.	
	C813	QFN82AJ-104	0.1MF 100V MYLAR CAP.	
	C814	QETB1HM-476	47MF 50V E. CAP.	
	C815	QETB1HM-476	47MF 50V E. CAP.	
	C816	QCF21HP-223A	0.022MF 50V CER. CAP.	BS
	C816	QCF21HP-223A	0.022MF 50V CER. CAP.	EF
	C816	QCF21HP-223A	0.022MF 50V CER. CAP.	EN
	C816	QCF21HP-223A	0.022MF 50V CER. CAP.	G
	C817	QCF21HP-223A	0.022MF 50V CER. CAP.	BS
	C817	QCF21HP-223A	0.022MF 50V CER. CAP.	EF
	C817	QCF21HP-223A	0.022MF 50V CER. CAP.	EN
	C817	QCF21HP-223A	0.022MF 50V CER. CAP.	G
	C820	QCB1HK-471Y	470PF 50V CER. CAP.	BS
	C820	QCB1HK-471Y	470PF 50V CER. CAP.	EF
	C820	QCB1HK-471Y	470PF 50V CER. CAP.	EN
	C820	QCB1HK-471Y	470PF 50V CER. CAP.	G
	C821	QETB1HM-476	47MF 50V E. CAP.	
	C822	QETB1HM-476	47MF 50V E. CAP.	
	C840	QETB1HM-476	47MF 50V E. CAP.	
	C841	QETB1HM-476	47MF 50V E. CAP.	
	C845	QETB1HM-476	47MF 50V E. CAP.	
	C853	QETB1EM-107	100MF 25V AL E. CAP.	
	C854	QETB1EM-107	100MF 25V AL E. CAP.	
	C861	QEZO225-478	4700MF E. CAP.	
	C862	QEZO225-478	4700MF E. CAP.	
	C863	QFN82CK-104	0.1MF 160V METAL. MYLAR	
	C864	QFN82CK-104	0.1MF 160V METAL. MYLAR	
	C865	QFN82CK-104	0.1MF 160V METAL. MYLAR	
	C866	QFN82CK-104	0.1MF 160V METAL. MYLAR	BS
	C866	QFN82CK-104	0.1MF 160V METAL. MYLAR	EF
	C866	QFN82CK-104	0.1MF 160V METAL. MYLAR	EN
	C866	QFN82CK-104	0.1MF 160V METAL. MYLAR	G
	C867	QFN82CK-104	0.1MF 160V METAL. MYLAR	BS
	C867	QFN82CK-104	0.1MF 160V METAL. MYLAR	EF
	C867	QFN82CK-104	0.1MF 160V METAL. MYLAR	EN
	C867	QFN82CK-104	0.1MF 160V METAL. MYLAR	G
	C868	QFN82CK-104	0.1MF 160V METAL. MYLAR	BS
	C868	QFN82CK-104	0.1MF 160V METAL. MYLAR	EF
	C868	QFN82CK-104	0.1MF 160V METAL. MYLAR	EN
	C868	QFN82CK-104	0.1MF 160V METAL. MYLAR	G
	C885	QETB1HM-105	1MF 50V AL E. CAP.	
	C896	QETB1EM-107	100MF 25V AL E. CAP.	
	C903	QETB1HM-226E	22MF 50V E. CAP.	
	C904	QCY31HK-102Z	1000PF 50V CER. CAP.	
	C905	QETC1AM-476ZM	47MF 10V E. CAP.	
	C906	QCF21HP-103A	0.01MF 50V CER. CAP.	
	C909	QETB1CM-226	22MF 16V E. CAP.	
	C925	QETB1HM-225	2.2MF 50V AL E. CAP.	
	C931	QFLB1HJ-223	0.022MF 50V MYLAR CAP.	BS
	C931	QFLB1HJ-223	0.022MF 50V MYLAR CAP.	EF
	C931	QFLB1HJ-223	0.022MF 50V MYLAR CAP.	EN
	C931	QFLB1HJ-223	0.022MF 50V MYLAR CAP.	G
	C932	QFLB1HJ-223	0.022MF 50V MYLAR CAP.	BS
	C932	QFLB1HJ-223	0.022MF 50V MYLAR CAP.	EF
	C932	QFLB1HJ-223	0.022MF 50V MYLAR CAP.	EN
	C932	QFLB1HJ-223	0.022MF 50V MYLAR CAP.	G
	C933	QFLB1HJ-223	0.022MF 50V MYLAR CAP.	BS
	C933	QFLB1HJ-223	0.022MF 50V MYLAR CAP.	EF

△	Item	Parts Number	Description	Area
	C933	QFLB1HJ-223	0.022MF 50V MYLAR CAP.	EN
	C933	QFLB1HJ-223	0.022MF 50V MYLAR CAP.	G
	C934	QFLB1HJ-223	0.022MF 50V MYLAR CAP.	BS
	C934	QFLB1HJ-223	0.022MF 50V MYLAR CAP.	EF
	C934	QFLB1HJ-223	0.022MF 50V MYLAR CAP.	EN
	C934	QFLB1HJ-223	0.022MF 50V MYLAR CAP.	G
	C935	QCS21HJ-221	220PF 50V CER. CAP.	BS
	C935	QCS21HJ-221	220PF 50V CER. CAP.	EF
	C935	QCS21HJ-221	220PF 50V CER. CAP.	EN
	C935	QCS21HJ-221	220PF 50V CER. CAP.	G
	C936	QCS21HJ-221	220PF 50V CER. CAP.	BS
	C936	QCS21HJ-221	220PF 50V CER. CAP.	EF
	C936	QCS21HJ-221	220PF 50V CER. CAP.	EN
	C936	QCS21HJ-221	220PF 50V CER. CAP.	G
	C937	QCS21HJ-221	220PF 50V CER. CAP.	BS
	C937	QCS21HJ-221	220PF 50V CER. CAP.	EF
	C937	QCS21HJ-221	220PF 50V CER. CAP.	EN
	C937	QCS21HJ-221	220PF 50V CER. CAP.	G
	C938	QCS21HJ-221	220PF 50V CER. CAP.	BS
	C938	QCS21HJ-221	220PF 50V CER. CAP.	EF
	C938	QCS21HJ-221	220PF 50V CER. CAP.	EN
	C938	QCS21HJ-221	220PF 50V CER. CAP.	G
	C941	QCS21HJ-221	220PF 50V CER. CAP.	BS
	C941	QCS21HJ-221	220PF 50V CER. CAP.	EF
	C941	QCS21HJ-221	220PF 50V CER. CAP.	EN
	C941	QCS21HJ-221	220PF 50V CER. CAP.	G
	C942	QCS21HJ-221	220PF 50V CER. CAP.	BS
	C942	QCS21HJ-221	220PF 50V CER. CAP.	EF
	C942	QCS21HJ-221	220PF 50V CER. CAP.	EN
	C942	QCS21HJ-221	220PF 50V CER. CAP.	G
	C943	QCS21HJ-221	220PF 50V CER. CAP.	BS
	C943	QCS21HJ-221	220PF 50V CER. CAP.	EF
	C943	QCS21HJ-221	220PF 50V CER. CAP.	EN
	C943	QCS21HJ-221	220PF 50V CER. CAP.	G
	C944	QCS21HJ-221	220PF 50V CER. CAP.	BS
	C944	QCS21HJ-221	220PF 50V CER. CAP.	EF
	C944	QCS21HJ-221	220PF 50V CER. CAP.	EN
	C944	QCS21HJ-221	220PF 50V CER. CAP.	G
	C945	QCS21HJ-221	220PF 50V CER. CAP.	BS
	C945	QCS21HJ-221	220PF 50V CER. CAP.	EF
	C945	QCS21HJ-221	220PF 50V CER. CAP.	EN
	C945	QCS21HJ-221	220PF 50V CER. CAP.	G
	C946	QCS21HJ-221	220PF 50V CER. CAP.	BS
	C946	QCS21HJ-221	220PF 50V CER. CAP.	EF
	C946	QCS21HJ-221	220PF 50V CER. CAP.	EN
	C946	QCS21HJ-221	220PF 50V CER. CAP.	G
	C955	QCB1HK-331Y	330PF 50V CER. CAP.	
	C956	QCB1HK-331Y	330PF 50V CER. CAP.	
	C961	QCB1HK-331Y	330PF 50V CER. CAP.	
	C962	QCB1HK-331Y	330PF 50V CER. CAP.	
	C971	QFLB1HJ-223	0.022MF 50V MYLAR CAP.	BS
	C971	QFLB1HJ-223	0.022MF 50V MYLAR CAP.	EF
	C971	QFLB1HJ-223	0.022MF 50V MYLAR CAP.	EN
	C971	QFLB1HJ-223	0.022MF 50V MYLAR CAP.	G
	C972	QCS21HJ-221	220PF 50V CER. CAP.	BS
	C972	QCS21HJ-221	220PF 50V CER. CAP.	EF
	C972	QCS21HJ-221	220PF 50V CER. CAP.	EN
	C972	QCS21HJ-221	220PF 50V CER. CAP.	G
	C973	QCS21HJ-221	220PF 50V CER. CAP.	BS
	C973	QCS21HJ-221	220PF 50V CER. CAP.	EF
	C973	QCS21HJ-221	220PF 50V CER. CAP.	EN
	C973	QCS21HJ-221	220PF 50V CER. CAP.	G
	C974	QCS21HJ-221	220PF 50V CER. CAP.	BS
	C974	QCS21HJ-221	220PF 50V CER. CAP.	EF
	C974	QCS21HJ-221	220PF 50V CER. CAP.	EN
	C974	QCS21HJ-221	220PF 50V CER. CAP.	G
	C981	QFLB1HJ-223	0.022MF 50V MYLAR CAP.	BS
	C981	QFLB1HJ-223	0.022MF 50V MYLAR CAP.	EF
	C981	QFLB1HJ-223	0.022MF 50V MYLAR CAP.	EN

AX-V5BK

Electrical Parts List (ENH-301)

△	Item	Parts Number	Description	Area
	C981	QFLB1HJ-223	0.022MF 50V MYLAR CAP.	G
	C982	QFLB1HJ-223	0.022MF 50V MYLAR CAP.	BS
	C982	QFLB1HJ-223	0.022MF 50V MYLAR CAP.	EF
	C982	QFLB1HJ-223	0.022MF 50V MYLAR CAP.	EN
	C982	QFLB1HJ-223	0.022MF 50V MYLAR CAP.	G
	C983	QCS21HJ-221	220PF 50V CER. CAP.	BS
	C983	QCS21HJ-221	220PF 50V CER. CAP.	EF
	C983	QCS21HJ-221	220PF 50V CER. CAP.	EN
	C983	QCS21HJ-221	220PF 50V CER. CAP.	G
	C984	QCS21HJ-221	220PF 50V CER. CAP.	BS
	C984	QCS21HJ-221	220PF 50V CER. CAP.	EF
	C984	QCS21HJ-221	220PF 50V CER. CAP.	EN
	C984	QCS21HJ-221	220PF 50V CER. CAP.	G
	C985	QCS21HJ-221	220PF 50V CER. CAP.	BS
	C985	QCS21HJ-221	220PF 50V CER. CAP.	EF
	C985	QCS21HJ-221	220PF 50V CER. CAP.	EN
	C985	QCS21HJ-221	220PF 50V CER. CAP.	G
	C986	QCS21HJ-221	220PF 50V CER. CAP.	BS
	C986	QCS21HJ-221	220PF 50V CER. CAP.	EF
	C986	QCS21HJ-221	220PF 50V CER. CAP.	EN
	C986	QCS21HJ-221	220PF 50V CER. CAP.	G
	C987	QCS21HJ-221	220PF 50V CER. CAP.	BS
	C987	QCS21HJ-221	220PF 50V CER. CAP.	EF
	C987	QCS21HJ-221	220PF 50V CER. CAP.	EN
	C987	QCS21HJ-221	220PF 50V CER. CAP.	G
		RESISTORS		
	R001	QRD161J-103	10K 1/6W CARBON RES.	U
	R001	QRD161J-103	10K 1/6W CARBON RES.	US
	R001	QRD161J-103	10K 1/6W CARBON RES.	UT
	R002	QRD161J-103	10K 1/6W CARBON RES.	U
	R002	QRD161J-103	10K 1/6W CARBON RES.	US
	R002	QRD161J-103	10K 1/6W CARBON RES.	UT
	R003	QRD161J-103	10K 1/6W CARBON RES.	U
	R003	QRD161J-103	10K 1/6W CARBON RES.	US
	R003	QRD161J-103	10K 1/6W CARBON RES.	UT
	R501	QRD161J-222	2.2K 1/6W CARBON RES.	
	R502	QRD161J-104	100K 1/6W CARBON RES.	
	R503	QRD161J-222	2.2K 1/6W CARBON RES.	
	R504	QRD161J-222	2.2K 1/6W CARBON RES.	
	R505	QRD161J-123	12K 1/6W CARBON RES.	U
	R505	QRD161J-123	12K 1/6W CARBON RES.	US
	R505	QRD161J-123	12K 1/6W CARBON RES.	UT
	R505	QRD161J-133Y	13K 1/6W CARBON RES.	BS
	R505	QRD161J-133Y	13K 1/6W CARBON RES.	EF
	R505	QRD161J-133Y	13K 1/6W CARBON RES.	EN
	R505	QRD161J-133Y	13K 1/6W CARBON RES.	G
	R507	QRD161J-104	100K 1/6W CARBON RES.	
	R508	QRD161J-102	1K 1/6W CARBON RES.	BS
	R508	QRD161J-102	1K 1/6W CARBON RES.	EF
	R508	QRD161J-102	1K 1/6W CARBON RES.	EN
	R508	QRD161J-102	1K 1/6W CARBON RES.	G
	R508	QRD161J-911	910 1/6W CARBON RES.	U
	R508	QRD161J-911	910 1/6W CARBON RES.	US
	R508	QRD161J-911	910 1/6W CARBON RES.	UT
△	R511	QRD14CJ-271S	270 1/4W UNF. CARBON R	BS
△	R511	QRD14CJ-271S	270 1/4W UNF. CARBON R	EF
△	R511	QRD14CJ-271S	270 1/4W UNF. CARBON R	EN
△	R511	QRD14CJ-271S	270 1/4W UNF. CARBON R	G
△	R511	QRD14CJ-301SX	300 1/4W UNF. CARBON R	U
△	R511	QRD14CJ-301SX	300 1/4W UNF. CARBON R	US
△	R511	QRD14CJ-301SX	300 1/4W UNF. CARBON R	UT
	R512	QRD167J-272	2.7K 1/6W CARBON RES.	
	R513	QRD167J-272	2.7K 1/6W CARBON RES.	
	R514	QRD167J-272	2.7K 1/6W CARBON RES.	
	R515	QRD167J-272	2.7K 1/6W CARBON RES.	
△	R517	QRD14CJ-100SX	10 1/4W UNF. CARBON R	
△	R518	QRD14CJ-100SX	10 1/4W UNF. CARBON R	
△	R523	QRD14CJ-100SX	10 1/4W UNF. CARBON R	
△	R524	QRD14CJ-100SX	10 1/4W UNF. CARBON R	

△	Item	Parts Number	Description	Area
△	R527	QRZ0195-R22	0.22 1W FUSIBLE RES.	
△	R528	QRD125J-330	33 1/2W UNF. CARBON R	
	R531	QRD161J-102	1K 1/6W CARBON RES.	
	R532	QRD161J-183	18K 1/6W CARBON RES.	
	R533	QRD161J-123	12K 1/6W CARBON RES.	
	R541	QRD161J-102	1K 1/6W CARBON RES.	
	R542	QRD161J-361	360 1/6W CARBON RES.	
	R543	QRD161J-181	180 1/6W CARBON RES.	
	R544	QRD161J-181	180 1/6W CARBON RES.	
	R545	QRD161J-181	180 1/6W CARBON RES.	
	R546	QRD161J-181	180 1/6W CARBON RES.	
△	R547	QRG022J-100A	10 2W OXIDE METAL	
	R548	QRD161J-104	100K 1/6W CARBON RES.	
	R549	QRD161J-301	300 1/6W CARBON RES.	
	R562	QRD161J-102	1K 1/6W CARBON RES.	
	R567	QRD161J-361	360 1/6W CARBON RES.	
△	R571	QRD14CJ-100SX	10 1/4W UNF. CARBON R	
△	R572	QRD14CJ-100SX	10 1/4W UNF. CARBON R	
△	R576	QRD161J-301	300 1/6W CARBON RES.	
△	R577	QRZ0195-R22	0.22 1W FUSIBLE RES.	
△	R581	QRD125J-330	33 1/2W UNF. CARBON R	
△	R582	QRG022J-100A	10 2W OXIDE METAL	
	R585	QRD161J-181	180 1/6W CARBON RES.	
	R586	QRD161J-181	180 1/6W CARBON RES.	
	R587	QRD161J-181	180 1/6W CARBON RES.	
	R588	QRD161J-181	180 1/6W CARBON RES.	
	R591	QRD161J-102	1K 1/6W CARBON RES.	
	R592	QRD161J-183	18K 1/6W CARBON RES.	
	R593	QRD161J-123	12K 1/6W CARBON RES.	
	R594	QRD161J-104	100K 1/6W CARBON RES.	
	R743	QRD161J-471	470 1/6W CARBON RES.	
	R744	QRD161J-471	470 1/6W CARBON RES.	
	R745	QRD161J-361	360 1/6W CARBON RES.	
	R746	QRD161J-361	360 1/6W CARBON RES.	
	R747	QRD161J-102	1K 1/6W CARBON RES.	
	R748	QRD161J-102	1K 1/6W CARBON RES.	
△	R751	QRD14CJ-100SX	10 1/4W UNF. CARBON R	
△	R752	QRD14CJ-100SX	10 1/4W UNF. CARBON R	
△	R753	QRD14CJ-100SX	10 1/4W UNF. CARBON R	
△	R754	QRD14CJ-100SX	10 1/4W UNF. CARBON R	
△	R771	QRZ0195-R22	0.22 1W FUSIBLE RES.	
△	R772	QRZ0195-R22	0.22 1W FUSIBLE RES.	
△	R773	QRD125J-330	33 1/2W UNF. CARBON R	
△	R774	QRD125J-330	33 1/2W UNF. CARBON R	
△	R775	QRG022J-100A	10 2W OXIDE METAL	
△	R776	QRG022J-100A	10 2W OXIDE METAL	
	R781	QRD161J-181	180 1/6W CARBON RES.	
	R782	QRD161J-181	180 1/6W CARBON RES.	
	R783	QRD161J-181	180 1/6W CARBON RES.	
	R784	QRD161J-181	180 1/6W CARBON RES.	
	R785	QRD161J-181	180 1/6W CARBON RES.	U
	R785	QRD161J-181	180 1/6W CARBON RES.	US
	R785	QRD161J-181	180 1/6W CARBON RES.	UT
	R785	QRD167J-151	150 1/6W CARBON RES.	BS
	R785	QRD167J-151	150 1/6W CARBON RES.	EF
	R785	QRD167J-151	150 1/6W CARBON RES.	EN
	R785	QRD167J-151	150 1/6W CARBON RES.	G
	R786	QRD161J-181	180 1/6W CARBON RES.	U
	R786	QRD161J-181	180 1/6W CARBON RES.	US
	R786	QRD161J-181	180 1/6W CARBON RES.	UT
	R786	QRD167J-151	150 1/6W CARBON RES.	BS
	R786	QRD167J-151	150 1/6W CARBON RES.	EF
	R786	QRD167J-151	150 1/6W CARBON RES.	EN
	R786	QRD167J-151	150 1/6W CARBON RES.	G
	R787	QRD161J-181	180 1/6W CARBON RES.	U
	R787	QRD161J-181	180 1/6W CARBON RES.	US
	R787	QRD161J-181	180 1/6W CARBON RES.	UT
	R787	QRD167J-151	150 1/6W CARBON RES.	BS
	R787	QRD167J-151	150 1/6W CARBON RES.	EF

Electrical Parts List (ENH-301)

△	Item	Parts Number	Description	Area
	R787	QRD167J-151	150 1/6W CARBON RES.	EN
	R787	QRD167J-151	150 1/6W CARBON RES.	G
	R788	QRD161J-181	180 1/6W CARBON RES.	U
	R788	QRD161J-181	180 1/6W CARBON RES.	US
	R788	QRD161J-181	180 1/6W CARBON RES.	UT
	R788	QRD167J-151	150 1/6W CARBON RES.	BS
	R788	QRD167J-151	150 1/6W CARBON RES.	EF
	R788	QRD167J-151	150 1/6W CARBON RES.	EN
	R788	QRD167J-151	150 1/6W CARBON RES.	G
△	R801	QRZ0076-3R3	3.3 1/4W FUSIBLE RES.	U
△	R801	QRZ0076-3R3	3.3 1/4W FUSIBLE RES.	US
△	R801	QRZ0076-3R3	3.3 1/4W FUSIBLE RES.	UT
△	R801	QRZ0077-220X	22 1/4W FUSIBLE RES.	BS
△	R801	QRZ0077-220X	22 1/4W FUSIBLE RES.	EF
△	R801	QRZ0077-220X	22 1/4W FUSIBLE RES.	EN
△	R801	QRZ0077-220X	22 1/4W FUSIBLE RES.	G
	R803	QRD14CJ-821SX	820 1/4W CARBON RES.	
△	R805	QRD14CJ-100SX	10 1/4W UNF. CARBON R	BS
△	R805	QRD14CJ-100SX	10 1/4W UNF. CARBON R	EF
△	R805	QRD14CJ-100SX	10 1/4W UNF. CARBON R	EN
△	R805	QRD14CJ-100SX	10 1/4W UNF. CARBON R	G
△	R806	QRD145J-153S	15K 1/4W UNF. CARBON R	U
△	R806	QRD145J-153S	15K 1/4W UNF. CARBON R	US
△	R806	QRD145J-153S	15K 1/4W UNF. CARBON R	UT
△	R807	QRG012J-332A	3.3K 1W OXIDE METAL	U
△	R807	QRG012J-332A	3.3K 1W OXIDE METAL	US
△	R807	QRG012J-332A	3.3K 1W OXIDE METAL	UT
△	R808	QRD14CJ-2R7S	2.7 1/4W UNF. CARBON R	BS
△	R808	QRD14CJ-2R7S	2.7 1/4W UNF. CARBON R	EF
△	R808	QRD14CJ-2R7S	2.7 1/4W UNF. CARBON R	EN
△	R808	QRD14CJ-2R7S	2.7 1/4W UNF. CARBON R	G
△	R808	QRD14CJ-3R3S	3.3 1/4W UNF. CARBON R	U
△	R808	QRD14CJ-3R3S	3.3 1/4W UNF. CARBON R	US
△	R808	QRD14CJ-3R3S	3.3 1/4W UNF. CARBON R	UT
△	R811	QRZ0077-100	10 1/4W FUSIBLE RES.	
△	R812	QRD14CJ-331SX	330 1/4W UNF. CARBON R	
△	R821	QRD14CJ-100SX	10 1/4W UNF. CARBON R	
△	R822	QRD14CJ-182SX	1.8K 1/4W UNF. CARBON R	
△	R840	QRD14CJ-220S	22 1/4W UNF. CARBON R	
△	R841	QRZ0077-100	10 1/4W FUSIBLE RES.	
△	R842	QRD143J-472S	4.7K 1/4W CARBON RES.	
△	R845	QRD14CJ-102SX	1K 1/4W UNF. CARBON R	
△	R853	QRG022J-100A	10 2W OXIDE METAL	
△	R854	QRD12CJ-562S	5.6K 1/2W UNF. CARBON R	
△	R860	QRD14CJ-220S	22 1/4W UNF. CARBON R	BS
△	R860	QRD14CJ-220S	22 1/4W UNF. CARBON R	EF
△	R860	QRD14CJ-220S	22 1/4W UNF. CARBON R	EN
△	R860	QRD14CJ-220S	22 1/4W UNF. CARBON R	G
	R861	QRD161J-104	100K 1/6W CARBON RES.	
	R862	QRD161J-104	100K 1/6W CARBON RES.	
	R885	QRD161J-104	100K 1/6W CARBON RES.	
△	R891	QRZ0077-100	10 1/4W FUSIBLE RES.	
△	R892	QRD14CJ-272S	2.7K 1/4W UNF. CARBON R	
	R901	QRD161J-102	1K 1/6W CARBON RES.	
	R902	QRD161J-102	1K 1/6W CARBON RES.	
	R903	QRD167J-153	15K 1/6W CARBON RES.	
	R904	QRD167J-153	15K 1/6W CARBON RES.	
	R905	QRD161J-123	12K 1/6W CARBON RES.	
	R906	QRD161J-123	12K 1/6W CARBON RES.	
	R909	QRD161J-104	100K 1/6W CARBON RES.	
	R910	QRD161J-823	82K 1/6W CARBON RES.	
	R911	QRD167J-332	3.3K 1/6W CARBON RES.	
	R912	QRD161J-473	47K 1/6W CARBON RES.	
	R913	QRD161J-103	10K 1/6W CARBON RES.	
	R915	QRD161J-823	82K 1/6W CARBON RES.	
	R916	QRD161J-563	56K 1/6W CARBON RES.	
	R917	QRD161J-683	68K 1/6W CARBON RES.	
	R918	QRD161J-392	3.9K 1/6W CARBON RES.	
	R919	QRD161J-122	1.2K 1/6W CARBON RES.	

△	Item	Parts Number	Description	Area
	R920	QRD161J-224	220K 1/6W CARBON RES.	
△	R921	QRD14CJ-470SX	47 1/4W UNF. CARBON R	
	R925	QRD167J-562	5.6K 1/6W CARBON RES.	
	R926	QRD167J-822	8.2K 1/6W CARBON RES.	
	R927	QRD161J-103	10K 1/6W CARBON RES.	
	R929	QRD161J-333	33K 1/6W CARBON RES.	
	R930	QRD161J-333	33K 1/6W CARBON RES.	
△	R931	QRZ0077-4R7	4.7 1/4W FUSE RESISTO	BS
△	R931	QRZ0077-4R7	4.7 1/4W FUSE RESISTO	EF
△	R931	QRZ0077-4R7	4.7 1/4W FUSE RESISTO	EN
△	R931	QRZ0077-4R7	4.7 1/4W FUSE RESISTO	G
△	R932	QRZ0077-4R7	4.7 1/4W FUSE RESISTO	BS
△	R932	QRZ0077-4R7	4.7 1/4W FUSE RESISTO	EF
△	R932	QRZ0077-4R7	4.7 1/4W FUSE RESISTO	EN
△	R932	QRZ0077-4R7	4.7 1/4W FUSE RESISTO	G
△	R933	QRZ0077-4R7	4.7 1/4W FUSE RESISTO	BS
△	R933	QRZ0077-4R7	4.7 1/4W FUSE RESISTO	EF
△	R933	QRZ0077-4R7	4.7 1/4W FUSE RESISTO	EN
△	R933	QRZ0077-4R7	4.7 1/4W FUSE RESISTO	G
△	R934	QRZ0077-4R7	4.7 1/4W FUSE RESISTO	BS
△	R934	QRZ0077-4R7	4.7 1/4W FUSE RESISTO	EF
△	R934	QRZ0077-4R7	4.7 1/4W FUSE RESISTO	EN
△	R934	QRZ0077-4R7	4.7 1/4W FUSE RESISTO	G
△	R951	QRD14CJ-220S	22 1/4W UNF. CARBON R	
	R955	QRD161J-102	1K 1/6W CARBON RES.	
	R956	QRD161J-333	33K 1/6W CARBON RES.	
	R957	QRD161J-104	100K 1/6W CARBON RES.	
	R958	QRD161J-104	100K 1/6W CARBON RES.	
△	R961	QRG022J-471A	470 2W OXIDE METAL	
△	R962	QRG022J-471A	470 2W OXIDE METAL	
△	R971	QRZ0077-4R7	4.7 1/4W FUSE RESISTO	BS
△	R971	QRZ0077-4R7	4.7 1/4W FUSE RESISTO	EF
△	R971	QRZ0077-4R7	4.7 1/4W FUSE RESISTO	EN
△	R971	QRZ0077-4R7	4.7 1/4W FUSE RESISTO	G
△	R981	QRZ0077-4R7	4.7 1/4W FUSE RESISTO	BS
△	R981	QRZ0077-4R7	4.7 1/4W FUSE RESISTO	EF
△	R981	QRZ0077-4R7	4.7 1/4W FUSE RESISTO	EN
△	R981	QRZ0077-4R7	4.7 1/4W FUSE RESISTO	G
△	R982	QRZ0077-4R7	4.7 1/4W FUSE RESISTO	BS
△	R982	QRZ0077-4R7	4.7 1/4W FUSE RESISTO	EF
△	R982	QRZ0077-4R7	4.7 1/4W FUSE RESISTO	EN
△	R982	QRZ0077-4R7	4.7 1/4W FUSE RESISTO	G
	VR741	QVPA601-102A	1K VARIABLE RES.	
	VR742	QVPA601-102A	1K VARIABLE RES.	
		OTHERS		
		EMW10678-105	PRINTED BOARD	
		QWE880-15RR	VINYL WIRE	U
		QWE880-15RR	VINYL WIRE	US
		QWE880-15RR	VINYL WIRE	UT
		QWE880-38RR	VINYL WIRE	EF
		QWE880-38RR	VINYL WIRE	EN
		QWE880-38RR	VINYL WIRE	G
		QWE880-38RR	VINYL WIRE	BS
		QWE881-16RR	VINYL WIRE	EF
		QWE881-16RR	VINYL WIRE	EN
		QWE881-16RR	VINYL WIRE	G
		QWE881-16RR	VINYL WIRE	U
		QWE881-16RR	VINYL WIRE	US
		QWE881-16RR	VINYL WIRE	UT
		QWE881-16RRBS	VINYL WIRE	BS
		QWE882-15RR	VINYL WIRE	U
		QWE882-15RR	VINYL WIRE	US
		QWE882-15RR	VINYL WIRE	UT
		QWE882-38RR	VINYL WIRE	EF
		QWE882-38RR	VINYL WIRE	EN
		QWE882-38RR	VINYL WIRE	G
		QWE882-38RR	VINYL WIRE	BS
		QWE883-15RR	VINYL WIRE	U
		QWE883-15RR	VINYL WIRE	US

AX-V5BK

Electrical Parts List (ENH-301)

△	Item	Parts Number	Description	Area
		QWE883-15RR	VINYL WIRE	UT
		QWE883-16RR	VINYL WIRE	BS
		QWE883-16RR	VINYL WIRE	EF
		QWE883-16RR	VINYL WIRE	EN
		QWE883-16RR	VINYL WIRE	G
		QWE884-15RR	VINYL WIRE	U
		QWE884-15RR	VINYL WIRE	US
		QWE884-15RR	VINYL WIRE	UT
		QWE884-20RR	VINYL WIRE	BS
		QWE884-20RR	VINYL WIRE	EF
		QWE884-20RR	VINYL WIRE	EN
		QWE884-20RR	VINYL WIRE	G
		QWE886-16RR	PIN WIRE	EF
		QWE886-16RR	PIN WIRE	EN
		QWE886-16RR	PIN WIRE	G
		QWE886-16RR	PIN WIRE	U
		QWE886-16RR	PIN WIRE	US
		QWE886-16RR	PIN WIRE	UT
		QWE886-16RRBS	VINYL WIRE	BS
		QWE888-15RR	VINYL WIRE	U
		QWE888-15RR	VINYL WIRE	US
		QWE888-15RR	VINYL WIRE	UT
		QWE889-15RR	VINYL WIRE	U
		QWE889-15RR	VINYL WIRE	US
		QWE889-15RR	VINYL WIRE	UT
		SBSG3008CC	TAPPING SCREW	
		SBSG3008CC	TAPPING SCREW	U
		SBSG3008CC	TAPPING SCREW	US
		SBSG3008CC	TAPPING SCREW	UT
	J955	EMN00TV-119AJ4	PIN JACK	
	J961	QMS6022-V01	MICROPHONE JACK	
	L501	EQL0011-R45J1	INDUCTOR	
	L581	EQL0011-R45J1	INDUCTOR	
	L771	EQL0011-R45J1	INDUCTOR	
	L772	EQL0011-R45J1	INDUCTOR	
	L931	EQL0011-R45J1	INDUCTOR	BS
	L931	EQL0011-R45J1	INDUCTOR	EF
	L931	EQL0011-R45J1	INDUCTOR	EN
	L931	EQL0011-R45J1	INDUCTOR	G
	L932	EQL0011-R45J1	INDUCTOR	BS
	L932	EQL0011-R45J1	INDUCTOR	EF
	L932	EQL0011-R45J1	INDUCTOR	EN
	L932	EQL0011-R45J1	INDUCTOR	G
	L971	EQL0011-R45J1	INDUCTOR	BS
	L971	EQL0011-R45J1	INDUCTOR	EF
	L971	EQL0011-R45J1	INDUCTOR	EN
	L971	EQL0011-R45J1	INDUCTOR	G
	L981	EQL0011-R45J1	INDUCTOR	BS
	L981	EQL0011-R45J1	INDUCTOR	EF
	L981	EQL0011-R45J1	INDUCTOR	EN
	L981	EQL0011-R45J1	INDUCTOR	G
	S901	QST4241-E05J2	PUSH SWITCH	
△	T801	ETP1000-41EA	POWER TRASNFORMER	EF
△	T801	ETP1000-41EA	POWER TRASNFORMER	EN
△	T801	ETP1000-41EA	POWER TRASNFORMER	G
△	T801	ETP1000-41EABS	POWER TRASNFORMER	BS
△	T801	ETP1000-41ZB	POWER TRASNFORMER	U
△	T801	ETP1000-41ZB	POWER TRASNFORMER	US
△	T801	ETP1000-41ZB	POWER TRASNFORMER	UT
	CN711	EMV7163-010	CONNECT TERMINAL	
	CN713	EMV7163-005	CONNECTOR	
	CN802	EMV7145-004Z	SOCKET ASSY	
	CN803	EMV7145-004Z	SOCKET ASSY	
	CN851	EMV7163-007	CONNECT TERMINAL	
	CN955	EMV7163-004	CONNECT TERMINAL	
	CN965	EMV5163-004R	CONNECT TERMINAL	
△	CP853	ICP-N15	I. C. PROTECTOR	
	EP110	EMZ4002-002Z	EARTH PLATE	BS
	EP110	EMZ4002-002Z	EARTH PLATE	EF

△	Item	Parts Number	Description	Area
	EP110	EMZ4002-002Z	EARTH PLATE	EN
	EP110	EMZ4002-002Z	EARTH PLATE	G
	EP500	EMZ4002-002Z	EARTH PLATE	
	EP800	E409182-001SM	EARTH TERMINAL	
	EP901	E409182-001SM	EARTH TERMINAL	BS
	EP901	E409182-001SM	EARTH TERMINAL	EF
	EP901	E409182-001SM	EARTH TERMINAL	EN
	EP901	E409182-001SM	EARTH TERMINAL	G
	EP961	EMZ4002-002Z	EARTH PLATE	
	FC801	EMG7331-003Z	FUSE CLIP	
	FC802	EMG7331-003Z	FUSE CLIP	
	FC803	EMG7331-003Z	FUSE CLIP	
	FC804	EMG7331-003Z	FUSE CLIP	
	FC805	EMG7331-003Z	FUSE CLIP	U
	FC805	EMG7331-003Z	FUSE CLIP	US
	FC805	EMG7331-003Z	FUSE CLIP	UT
	FC806	EMG7331-003Z	FUSE CLIP	U
	FC806	EMG7331-003Z	FUSE CLIP	US
	FC806	EMG7331-003Z	FUSE CLIP	UT
	FC810	EMG7331-003Z	FUSE CLIP	
	FC811	EMG7331-003Z	FUSE CLIP	
	FC812	EMG7331-003Z	FUSE CLIP	
	FC813	EMG7331-003Z	FUSE CLIP	
	FW801	EWR3AD-13SS	FLAT WIRE	
	FW901	EWR36D-40SS	CORD	
	FW902	EWR35B-16SST	FLAT WIRE	
	FW961	EWR33D-10SS	CORD	
	HS805	E70945-H40B	HEAT SINK	U
	HS805	E70945-H40B	HEAT SINK	US
	HS805	E70945-H40B	HEAT SINK	UT
	HS841	E70306-001	HEAT SINK	
	HS851	E70945-H40B	HEAT SINK	
	LA101	E67132-T2R0	FUSE LABEL	BS
	LA101	E67132-T2R0	FUSE LABEL	EF
	LA101	E67132-T2R0	FUSE LABEL	EN
	LA101	E67132-T2R0	FUSE LABEL	G
△	RY801	ESK1D12-119J3	RELAY	
△	RY860	QSK0064-001	RELAY	BS
△	RY860	QSK0064-001	RELAY	EF
△	RY860	QSK0064-001	RELAY	EN
△	RY860	QSK0064-001	RELAY	G
	RY901	ESK7D24-213R	RELAY	
	RY951	ESK7D24-213R	RELAY	
	ST901	FMMJ4002-001	SPEAKER TERMINAL	
	ST951	EMB90TV-601G	SPEAKER TERMINAL	U
	ST951	EMB90TV-601G	SPEAKER TERMINAL	US
	ST951	EMB90TV-601G	SPEAKER TERMINAL	UT
	ST951	EMB90TV-602G	SPEAKER TERMINAL	BS
	ST951	EMB90TV-602G	SPEAKER TERMINAL	EF
	ST951	EMB90TV-602G	SPEAKER TERMINAL	EN
	ST951	EMB90TV-602G	SPEAKER TERMINAL	G
△	SW001	QSW0467-001	PUSH SWITCH	EF
△	SW001	QSW0467-001	PUSH SWITCH	EN
△	SW001	QSW0467-001	PUSH SWITCH	G
△	SW001	QSW0467-001BS	PUSH SW.	BS
	TA801	EMZ4001-002Z	TAB	
	TA802	EMZ4001-002Z	TAB	
	TH540	ERT-D2WHL202S	NEGATIVE THERMISTOR	
	TH568	ERT-D2WHL202S	NEGATIVE THERMISTOR	
	TH749	ERT-D2WHL202S	NEGATIVE THERMISTOR	
	TH750	ERT-D2WHL202S	NEGATIVE THERMISTOR	
	TP001	QMV5005-004K	PLUG ASSY	
△	VS801	QSW0524-001	LEVER SWITCH	U
△	VS801	QSW0524-001	LEVER SWITCH	US
△	VS801	QSW0524-001	LEVER SWITCH	UT

Electrical Parts List (ENB-246)

△	Item	Parts Number	Description	Area
		I. C. S		
	IC401	MN173222JAAM1	I. C (MICRO-COMPUTER)	
	IC402	GP1U271X	INFRARED DETECT UNIT	
	IC403	PST600E-T	I. C (MONO-ANALOG)	
		DIODES		
	D401	1SR139-200	SI. DIODE	
	D402	1SS133	SI. DIODE	
	D403	1SS133	SI. DIODE	
	D404	1SS133	SI. DIODE	
	D410	1SS133	SI. DIODE	
	D411	SLA-380JT3F	L. E. D.	BS
	D411	SLA-380JT3F	L. E. D.	EF
	D411	SLA-380JT3F	L. E. D.	EN
	D411	SLA-380JT3F	L. E. D.	G
	D411	SLR-342VC3F	L. E. D.	U
	D411	SLR-342VC3F	L. E. D.	US
	D411	SLR-342VC3F	L. E. D.	UT
	D418	SLR-342MCA47	L. E. D.	
	D420	SLR-342MCA47	L. E. D.	
	D421	SLR-342MCA47	L. E. D.	
	D422	SLR-342MCA47	L. E. D.	
	D423	SLR-342MCA47	L. E. D.	
	D424	SLR-342MCA47	L. E. D.	
	D431	1SS133	SI. DIODE	
	D432	1SS133	SI. DIODE	
	D433	1SS133	SI. DIODE	
	D434	1SS133	SI. DIODE	
	D441	1SS133	SI. DIODE	
	D442	1SS133	SI. DIODE	
	D443	1SS133	SI. DIODE	U
	D443	1SS133	SI. DIODE	US
	D443	1SS133	SI. DIODE	UT
	D553	1SS133	SI. DIODE	
	D703	1SS133	SI. DIODE	
	D704	1SS133	SI. DIODE	
	D711	SLR-342MG-TA	L. E. D.	
	D712	SLR-342MG-TA	L. E. D.	
		TRANSISTORS		
	Q401	DTC114YS	DIGITAL TRANSISTOR	
	Q402	DTC114TN	DIGITAL TRANSISTOR	
	Q403	DTC144WS	DIGITAL TRANSISTOR	
	Q410	DTC114YS	DIGITAL TRANSISTOR	
	Q411	DTC114YS	DIGITAL TRANSISTOR	
	Q412	DTC114YS	DIGITAL TRANSISTOR	
	Q413	DTC114YS	DIGITAL TRANSISTOR	
	Q414	DTC114YS	DIGITAL TRANSISTOR	
	Q551	2SC2240 (BL)	SI. TRANSISTOR	
	Q552	2SC2240 (BL)	SI. TRANSISTOR	
	Q561	2SA1038 (R, S)	SI. TRANSISTOR	
	Q701	2SC2240 (BL)	SI. TRANSISTOR	
	Q702	2SC2240 (BL)	SI. TRANSISTOR	
	Q703	2SC2240 (BL)	SI. TRANSISTOR	
	Q704	2SC2240 (BL)	SI. TRANSISTOR	
	Q707	2SA1038 (R, S)	SI. TRANSISTOR	
	Q708	2SA1038 (R, S)	SI. TRANSISTOR	
	Q711	2SC2389 (S, E)	SI. TRANSISTOR	
	Q712	2SC2389 (S, E)	SI. TRANSISTOR	
		CAPACITORS		
	C401	QETB1AM-227	220MF 10V E. CAP.	
	C402	QCZ0202-155	1.5MF 25V CER. RES.	
	C403	QEAD0HZ-10AZM	AL E. CAP.	
	C404	QETB1HM-225	2.2MF 50V AL E. CAP.	
	C405	QCHB1EZ-223	0.022MF 25V CER. CAP.	
	C406	QCB1HK-331Y	330PF 50V CER. CAP.	
	C411	QETB1HM-475E	4.7MF 50V E. CAP.	
	C412	QETB1HM-475E	4.7MF 50V E. CAP.	
	C413	QETC1AM-107ZN	100MF 10V E. CAP.	
	C414	QETB1HM-475E	4.7MF 50V E. CAP.	
	C551	QETB1HM-106	10MF 50V E. CAP.	

△	Item	Parts Number	Description	Area
	C552	QCS21HJ-271A	270PF 50V CER. CAP.	
	C553	QCS21HJ-101A	100PF 50V CER. CAP.	
	C556	QCY31HK-152Z	1500PF 50V CER. CAP.	
	C557	QCS21HJ-100	10PF 50V CER. CAP.	
	C558	QETB1CM-476	47MF 16V AL E. CAP.	
	C561	QETB1HM-225	2.2MF 50V AL E. CAP.	
	C562	QCS22HJ-330	33PF 500V CER. CAP.	
	C563	QFLB1HJ-103	0.01MF 50V MYLAR CAP.	
	C564	QETB1HM-476	47MF 50V E. CAP.	
	C701	QETB1HM-106	10MF 50V E. CAP.	
	C702	QETB1HM-106	10MF 50V E. CAP.	
	C703	QCS21HJ-271A	270PF 50V CER. CAP.	
	C704	QCS21HJ-271A	270PF 50V CER. CAP.	
	C705	QCS21HJ-101A	100PF 50V CER. CAP.	
	C706	QCS21HJ-101A	100PF 50V CER. CAP.	
	C711	QETB1CM-107	100MF 16V AL E. CAP.	
	C712	QETB1CM-107	100MF 16V AL E. CAP.	
	C713	QCS21HJ-100	10PF 50V CER. CAP.	
	C714	QCS21HJ-100	10PF 50V CER. CAP.	
	C717	QCY31HK-152Z	1500PF 50V CER. CAP.	
	C718	QCY31HK-152Z	1500PF 50V CER. CAP.	
	C721	QCS22HJ-220	22PF 500V CER. CAP.	
	C722	QCS22HJ-220	22PF 500V CER. CAP.	
	C723	QETB1HM-225	2.2MF 50V AL E. CAP.	
	C724	QETB1HM-225	2.2MF 50V AL E. CAP.	
	C727	QFLB1HJ-104	0.1MF 50V MYLAR CAP.	
	C728	QFLB1HJ-104	0.1MF 50V MYLAR CAP.	
	C739	QETB1JM-107	100MF 63V AL E. CAP.	
		RESISTORS		
	R402	QRD161J-331	330 1/6W CARBON RES.	
	R403	QRD161J-223	22K 1/6W CARBON RES.	
	R404	QRD161J-103	10K 1/6W CARBON RES.	
	R405	QRD161J-472	4.7K 1/6W CARBON RES.	
	R408	QRD161J-103	10K 1/6W CARBON RES.	
	R409	QRD161J-471	470 1/6W CARBON RES.	
	R410	QRD161J-103	10K 1/6W CARBON RES.	
	R411	QRD161J-221	220 1/6W CARBON RES.	
	R412	QRD161J-103	10K 1/6W CARBON RES.	
	R413	QRD161J-103	10K 1/6W CARBON RES.	
	R414	QRD161J-103	10K 1/6W CARBON RES.	
	R417	QRD161J-221	220 1/6W CARBON RES.	
	R418	QRD161J-221	220 1/6W CARBON RES.	
	R419	QRD161J-472	4.7K 1/6W CARBON RES.	
	R420	QRD161J-104	100K 1/6W CARBON RES.	
	R421	QRD161J-104	100K 1/6W CARBON RES.	
	R422	QRD161J-104	100K 1/6W CARBON RES.	
	R433	QRD161J-104	100K 1/6W CARBON RES.	
	R434	QRD161J-104	100K 1/6W CARBON RES.	
	R435	QRD161J-104	100K 1/6W CARBON RES.	
	R436	QRD161J-221	220 1/6W CARBON RES.	
	R437	QRD161J-221	220 1/6W CARBON RES.	
	R438	QRD161J-221	220 1/6W CARBON RES.	
	R439	QRD161J-221	220 1/6W CARBON RES.	
	R440	QRD161J-221	220 1/6W CARBON RES.	
	R441	QRD161J-221	220 1/6W CARBON RES.	
	R442	QRD161J-221	220 1/6W CARBON RES.	
	R443	QRD161J-221	220 1/6W CARBON RES.	
	R444	QRD161J-221	220 1/6W CARBON RES.	
	R445	QRD161J-221	220 1/6W CARBON RES.	
	R446	QRD161J-221	220 1/6W CARBON RES.	
	R447	QRD161J-221	220 1/6W CARBON RES.	
	R448	QRD161J-221	220 1/6W CARBON RES.	
	R449	QRD161J-221	220 1/6W CARBON RES.	
	R450	QRD161J-221	220 1/6W CARBON RES.	
	R451	QRD161J-221	220 1/6W CARBON RES.	
	R452	QRD161J-221	220 1/6W CARBON RES.	
	R453	QRD161J-221	220 1/6W CARBON RES.	
	R551	QRD161J-222	2.2K 1/6W CARBON RES.	
	R552	QRD161J-104	100K 1/6W CARBON RES.	

AX-V5BK

Electrical Parts List (ENB-246)

△	Item	Parts Number	Description	Area
	R553	QRD161J-222	2.2K 1/6W CARBON RES.	
	R554	QRD161J-222	2.2K 1/6W CARBON RES.	
	R555	QRD161J-123	12K 1/6W CARBON RES.	U
	R555	QRD161J-123	12K 1/6W CARBON RES.	US
	R555	QRD161J-123	12K 1/6W CARBON RES.	UT
	R555	QRD161J-133Y	13K 1/6W CARBON RES.	BS
	R555	QRD161J-133Y	13K 1/6W CARBON RES.	EF
	R555	QRD161J-133Y	13K 1/6W CARBON RES.	EN
	R555	QRD161J-133Y	13K 1/6W CARBON RES.	G
	R556	QRD161J-101	100 1/6W CARBON RES.	
	R558	QRD161J-102	1K 1/6W CARBON RES.	BS
	R558	QRD161J-102	1K 1/6W CARBON RES.	EF
	R558	QRD161J-102	1K 1/6W CARBON RES.	EN
	R558	QRD161J-102	1K 1/6W CARBON RES.	G
	R558	QRD161J-911	910 1/6W CARBON RES.	U
	R558	QRD161J-911	910 1/6W CARBON RES.	US
	R558	QRD161J-911	910 1/6W CARBON RES.	UT
	R560	QRD161J-104	100K 1/6W CARBON RES.	
△	R561	QRD14CJ-271S	270 1/4W UNF. CARBON R	BS
△	R561	QRD14CJ-271S	270 1/4W UNF. CARBON R	EF
△	R561	QRD14CJ-271S	270 1/4W UNF. CARBON R	EN
△	R561	QRD14CJ-271S	270 1/4W UNF. CARBON R	G
△	R561	QRD14CJ-301SX	300 1/4W UNF. CARBON R	U
△	R561	QRD14CJ-301SX	300 1/4W UNF. CARBON R	US
△	R561	QRD14CJ-301SX	300 1/4W UNF. CARBON R	UT
	R563	QRD167J-272	2.7K 1/6W CARBON RES.	
	R564	QRD167J-272	2.7K 1/6W CARBON RES.	
	R565	QRD167J-272	2.7K 1/6W CARBON RES.	
	R566	QRD167J-272	2.7K 1/6W CARBON RES.	
△	R569	QRD14CJ-100SX	10 1/4W UNF. CARBON R	
△	R570	QRD14CJ-100SX	10 1/4W UNF. CARBON R	
	R701	QRD161J-222	2.2K 1/6W CARBON RES.	
	R702	QRD161J-222	2.2K 1/6W CARBON RES.	
	R703	QRD161J-104	100K 1/6W CARBON RES.	
	R704	QRD161J-104	100K 1/6W CARBON RES.	
	R705	QRD161J-202	2K 1/6W CARBON RES.	
	R706	QRD161J-202	2K 1/6W CARBON RES.	
	R707	QRD161J-202	2K 1/6W CARBON RES.	
	R708	QRD161J-202	2K 1/6W CARBON RES.	
	R709	QRD161J-123	12K 1/6W CARBON RES.	
	R710	QRD161J-123	12K 1/6W CARBON RES.	
	R711	QRD161J-102	1K 1/6W CARBON RES.	BS
	R711	QRD161J-102	1K 1/6W CARBON RES.	EF
	R711	QRD161J-102	1K 1/6W CARBON RES.	EM
	R711	QRD161J-102	1K 1/6W CARBON RES.	G
	R711	QRD161J-911	910 1/6W CARBON RES.	U
	R711	QRD161J-911	910 1/6W CARBON RES.	US
	R711	QRD161J-911	910 1/6W CARBON RES.	UT
	R712	QRD161J-102	1K 1/6W CARBON RES.	BS
	R712	QRD161J-102	1K 1/6W CARBON RES.	EF
	R712	QRD161J-102	1K 1/6W CARBON RES.	EN
	R712	QRD161J-102	1K 1/6W CARBON RES.	G
	R712	QRD161J-911	910 1/6W CARBON RES.	U
	R712	QRD161J-911	910 1/6W CARBON RES.	US
	R712	QRD161J-911	910 1/6W CARBON RES.	UT
	R713	QRD161J-104	100K 1/6W CARBON RES.	
	R714	QRD161J-104	100K 1/6W CARBON RES.	
	R717	QRD161J-101	100 1/6W CARBON RES.	
	R718	QRD161J-101	100 1/6W CARBON RES.	
△	R721	QRD14CJ-271S	270 1/4W UNF. CARBON R	
△	R722	QRD14CJ-271S	270 1/4W UNF. CARBON R	
	R727	QRD161J-473	47K 1/6W CARBON RES.	
	R728	QRD161J-473	47K 1/6W CARBON RES.	
△	R729	QRD14CJ-331SX	330 1/4W UNF. CARBON R	
△	R730	QRD14CJ-331SX	330 1/4W UNF. CARBON R	
△	R739	QRD14CJ-100SX	10 1/4W UNF. CARBON R	
△	R740	QRD14CJ-100SX	10 1/4W UNF. CARBON R	
	RA401	QRB079J-103	10K 1/10WRES.	
	RA402	QRB109J-103	10K 1/10WNETWORK RES.	

△	Item	Parts Number	Description	Area
		OTHERS		
		EMW10682-002	PRINTED BOARD	
	S401	ESP0001-023M	TACT SWITCH	
	S402	ESP0001-023M	TACT SWITCH	
	S403	ESP0001-023M	TACT SWITCH	
	S405	ESP0001-023M	TACT SWITCH	
	S406	ESP0001-023M	TACT SWITCH	
	S407	ESP0001-023M	TACT SWITCH	
	S408	ESP0001-023M	TACT SWITCH	
	S410	ESP0001-023M	TACT SWITCH	
	S411	ESP0001-023M	TACT SWITCH	
	S412	ESP0001-023M	TACT SWITCH	
	S413	ESP0001-023M	TACT SWITCH	
	X401	ECXP6R0-001ZA	CRYSTAL	
	CN314	VMC0163-021	CONNECT TERMINAL	
	CN421	EWS26D-A408J	SOCKET WIRE ASSY	
	CN431	EMV5109-013A	CONNECT TERMINAL	
	CN701	EMV5163-010R	CONNECT TERMINAL	
	CN703	EMV5163-005R	CONNECTOR	
	CN712	EMV5109-006B	CONNECT TERMINAL	
	D1401	QLF0002-001	FLUORESCENT DISPLAY TUBE	
	FH001	E309106-001SM	FL HOLDER	
	FS001	E3400-444	FELT SPACER	
	FS002	E3400-444	FELT SPACER	
	FW801	EWR38D-16LS	FLAT WIRE	
	JS401	QSJ4003-E01	PUSH SWITCH	

Electrical Parts List (ENC-135)

△	Item	Parts Number	Description	Area
		I. C. S		
	IC201	TC9212P	I. C (DIGI-MOS)	
	IC202	TC9212P	I. C (DIGI-MOS)	
	IC203	BA15218N	I. C (MONO-ANALOG)	
	IC204	BA15218	I. C (MONO-ANALOG)	
	IC251	M5243P12	I. C (MONO-ANALOG)	
	IC252	TC9163AN	I. C (DIGI-MOS)	
	IC301	NJM4580DD	I. C (MONO-ANALOG)	
	IC321	TC9164AN	I. C (DIGI-MOS)	
	IC341	BA15218	I. C (MONO-ANALOG)	
	IC361	BA15218	I. C (MONO-ANALOG)	
	IC601	LA2786	I. C (MONO-ANALOG)	
	IC641	LV1016	I. C (M)	
	IC671	NJM2246D	I. C (MONO-ANALOG)	
		DIODES		
	D251	MTZ6.8JC	ZENER DIODE	
	D252	MTZ6.8JC	ZENER DIODE	
		TRANSISTORS		
	Q221	2SD2144S (VW)	SI. TRANSISTOR	
	Q222	2SD2144S (VW)	SI. TRANSISTOR	
	Q223	2SD2144S (VW)	SI. TRANSISTOR	
	Q224	2SD2144S (VW)	SI. TRANSISTOR	
	Q225	DTA144ES	DIGITAL TRANSISTOR	
	Q671	2SA933S (RS)	SI. TRANSISTOR	
	Q672	2SC458 (C. D)	SI. TRANSISTOR	
	Q673	DTC143ES	DIGITAL TRANSISTOR	
	Q674	2SA933S (RS)	SI. TRANSISTOR	
	Q675	2SC458 (C. D)	SI. TRANSISTOR	
		CAPACITORS		
	C201	QETB1HM-475E	4.7MF 50V E. CAP.	
	C202	QETB1HM-475E	4.7MF 50V E. CAP.	
	C203	QETB1HM-225	2.2MF 50V AL E. CAP.	
	C204	QETB1HM-225	2.2MF 50V AL E. CAP.	
	C205	QCBB1HK-561Y	560PF 50V CER. CAP.	
	C206	QCBB1HK-561Y	560PF 50V CER. CAP.	
	C207	QFN81HK-154	0.15MF 50V METAL. MYLAR	
	C208	QFN81HK-154	0.15MF 50V METAL. MYLAR	
	C209	QETB1HM-475E	4.7MF 50V E. CAP.	
	C210	QETB1HM-475E	4.7MF 50V E. CAP.	
	C211	QETB1HM-475E	4.7MF 50V E. CAP.	
	C212	QETB1HM-475E	4.7MF 50V E. CAP.	
	C213	QETB1HM-225	2.2MF 50V AL E. CAP.	
	C214	QETB1HM-225	2.2MF 50V AL E. CAP.	
	C215	QETB1HM-475E	4.7MF 50V E. CAP.	
	C216	QETB1HM-475E	4.7MF 50V E. CAP.	
	C225	QETB1HM-475E	4.7MF 50V E. CAP.	
	C251	QETB1HM-475E	4.7MF 50V E. CAP.	
	C252	QETB1HM-475E	4.7MF 50V E. CAP.	
	C253	QCBB1HK-101Y	100PF 50V CER. CAP.	
	C254	QCBB1HK-101Y	100PF 50V CER. CAP.	
	C255	QETB1EM-476	47MF 25V AL E. CAP.	
	C256	QETB1EM-476	47MF 25V AL E. CAP.	
	C257	QETB1EM-476	47MF 25V AL E. CAP.	
	C258	QETB1EM-476	47MF 25V AL E. CAP.	
	C259	QCSB1HJ-100Y	10PF 50V CER. CAP.	
	C260	QCSB1HJ-100Y	10PF 50V CER. CAP.	
	C261	QCSB1HJ-100Y	10PF 50V CER. CAP.	
	C262	QCSB1HJ-100Y	10PF 50V CER. CAP.	
	C265	QETB1EM-226N	22MF 25V E. CAP.	
	C266	QETB1EM-226N	22MF 25V E. CAP.	
	C269	QCHB1EZ-223	0.022MF 25V CER. CAP.	
	C270	QCHB1EZ-223	0.022MF 25V CER. CAP.	
	C271	QFLB1HJ-272	2700PF 50V MYLAR CAP.	
	C272	QFLB1HJ-272	2700PF 50V MYLAR CAP.	
	C273	QCBB1HK-471Y	470PF 50V CER. CAP.	
	C274	QCBB1HK-471Y	470PF 50V CER. CAP.	
	C275	QFV81HJ-473	0.047MF 50V THIN FILM CAP.	
	C276	QFV81HJ-473	0.047MF 50V THIN FILM CAP.	
	C277	QFLB1HJ-822	8200PF 50V MYLAR CAP.	

△	Item	Parts Number	Description	Area
	C278	QFLB1HJ-822	8200PF 50V MYLAR CAP.	
	C279	QER51HM-684	0.68MF 50V AL E. CAP.	
	C280	QER51HM-684	0.68MF 50V AL E. CAP.	
	C281	QFV81HJ-104	0.1MF 50V THIN FILM CAP.	
	C282	QFV81HJ-104	0.1MF 50V THIN FILM CAP.	
	C283	QCSB1HJ-470	47PF 50V CER. CAP.	
	C284	QCSB1HJ-470	47PF 50V CER. CAP.	
	C287	QCBB1HK-561Y	560PF 50V CER. CAP.	
	C295	QCBB1HK-221Y	220PF 50V CER. CAP.	
	C296	QCBB1HK-221Y	220PF 50V CER. CAP.	
	C297	QCBB1HK-221Y	220PF 50V CER. CAP.	
	C298	QCBB1HK-221Y	220PF 50V CER. CAP.	
	C300	QCHB1EZ-223	0.022MF 25V CER. CAP.	
	C301	QETB1HM-475E	4.7MF 50V E. CAP.	
	C302	QETB1HM-475E	4.7MF 50V E. CAP.	
	C303	QCBB1HK-101Y	100PF 50V CER. CAP.	
	C304	QCBB1HK-101Y	100PF 50V CER. CAP.	
	C305	QFN81HK-182	1800PF 50V METAL. MYLAR	
	C306	QFN81HK-182	1800PF 50V METAL. MYLAR	
	C307	QFN31HK-682Z	6800PF 50V MYLAR CAP.	
	C308	QFN31HK-682Z	6800PF 50V MYLAR CAP.	
	C309	QCBB1HK-101Y	100PF 50V CER. CAP.	
	C310	QCBB1HK-101Y	100PF 50V CER. CAP.	
	C311	QETB1HM-475E	4.7MF 50V E. CAP.	
	C312	QETB1HM-475E	4.7MF 50V E. CAP.	
	C313	QETC1AM-107ZN	100MF 10V E. CAP.	
	C314	QETC1AM-107ZN	100MF 10V E. CAP.	
	C315	QETB1CM-476	47MF 16V AL E. CAP.	
	C316	QETB1CM-476	47MF 16V AL E. CAP.	
	C319	QCBB1HK-331Y	330PF 50V CER. CAP.	
	C320	QCBB1HK-331Y	330PF 50V CER. CAP.	
	C323	QCHB1EZ-223	0.022MF 25V CER. CAP.	
	C324	QCHB1EZ-223	0.022MF 25V CER. CAP.	
	C325	QCBB1HK-221Y	220PF 50V CER. CAP.	
	C341	QETB1HM-106	10MF 50V E. CAP.	
	C342	QETB1HM-106	10MF 50V E. CAP.	
	C361	QETB1HM-475E	4.7MF 50V E. CAP.	
	C362	QETB1HM-475E	4.7MF 50V E. CAP.	
	C371	QCBB1HK-221Y	220PF 50V CER. CAP.	
	C381	QCBB1HK-331Y	330PF 50V CER. CAP.	
	C382	QCBB1HK-331Y	330PF 50V CER. CAP.	
	C385	QCBB1HK-331Y	330PF 50V CER. CAP.	
	C386	QCBB1HK-331Y	330PF 50V CER. CAP.	
	C387	QCBB1HK-331Y	330PF 50V CER. CAP.	
	C388	QCBB1HK-331Y	330PF 50V CER. CAP.	
	C389	QCBB1HK-331Y	330PF 50V CER. CAP.	
	C390	QCBB1HK-331Y	330PF 50V CER. CAP.	
	C393	QCBB1HK-331Y	330PF 50V CER. CAP.	
	C394	QCBB1HK-331Y	330PF 50V CER. CAP.	
	C395	QCBB1HK-331Y	330PF 50V CER. CAP.	
	C396	QCBB1HK-331Y	330PF 50V CER. CAP.	
	C397	QCBB1HK-331Y	330PF 50V CER. CAP.	
	C398	QCBB1HK-331Y	330PF 50V CER. CAP.	
	C601	QETB1HM-105	1MF 50V AL E. CAP.	
	C602	QETB1HM-105	1MF 50V AL E. CAP.	
	C603	QFLB1HJ-104	0.1MF 50V MYLAR CAP.	
	C604	QFLB1HJ-104	0.1MF 50V MYLAR CAP.	
	C605	QFLB1HJ-104	0.1MF 50V MYLAR CAP.	
	C606	QFLB1HJ-104	0.1MF 50V MYLAR CAP.	
	C607	QETB1HM-474	0.47MF 50V E. CAP.	
	C608	QETB1HM-474	0.47MF 50V E. CAP.	
	C609	QETB1HM-475E	4.7MF 50V E. CAP.	
	C610	QETB1HM-475E	4.7MF 50V E. CAP.	
	C611	QETB1HM-474	0.47MF 50V E. CAP.	
	C612	QETB1HM-474	0.47MF 50V E. CAP.	
	C613	QETB1HM-475E	4.7MF 50V E. CAP.	
	C614	QETB1HM-475E	4.7MF 50V E. CAP.	
	C615	QFV81HJ-154	0.15MF 50V THIN FILM CAP.	
	C616	QFV81HJ-154	0.15MF 50V THIN FILM CAP.	

AX-V5BK

Electrical Parts List (ENC-135)

△	Item	Parts Number	Description	Area
	C617	QETB1HM-335	3.3MF 50V AL E. CAP.	
	C618	QETB1HM-335	3.3MF 50V AL E. CAP.	
	C619	QFV81HJ-154	0.15MF 50V THIN FILM CAP.	
	C620	QFV81HJ-154	0.15MF 50V THIN FILM CAP.	
	C621	QFN31HJ-223ZN	0.022MF 50V MYLAR CAP.	
	C622	QFN31HJ-473ZN	0.047MF 50V MYLAR CAP.	
	C623	QETC1EM-227ZN	220MF 25V AL E. CAP.	
	C624	QETB1EM-106	10MF 25V AL E. CAP.	
	C625	QETB1EM-106	10MF 25V AL E. CAP.	
	C626	QETB1EM-106	10MF 25V AL E. CAP.	
	C627	QETB1EM-106	10MF 25V AL E. CAP.	
	C628	QETC1EM-227ZN	220MF 25V AL E. CAP.	
	C631	QETB1EM-476	47MF 25V AL E. CAP.	
	C632	QFV71HJ-474ZM	0.47MF 50V THIN FILM CAP.	
	C633	QCB1HK-681Y	680PF 50V CER. CAP.	
	C634	QETC1EM-227ZN	220MF 25V AL E. CAP.	
	C641	QETB1HM-474	0.47MF 50V E. CAP.	
	C642	QETC1EM-227ZN	220MF 25V AL E. CAP.	
	C643	QETB1HM-225	2.2MF 50V AL E. CAP.	
	C645	QFN81HJ-823	0.082MF 50V METAL. MYLAR	
	C646	QFN31HJ-332Z	3300PF 50V MYLAR CAP.	
	C647	QFN81HJ-823	0.082MF 50V METAL. MYLAR	
	C648	QETB1HM-474	0.47MF 50V E. CAP.	
	C650	QETC1EM-227ZN	220MF 25V AL E. CAP.	
	C651	QCSB1HJ-330Y	33PF 50V CER. CAP.	
	C652	QCSB1HJ-330Y	33PF 50V CER. CAP.	
	C653	QCHB1EZ-223	0.022MF 25V CER. CAP.	
	C671	QETB1CM-107	100MF 16V AL E. CAP.	
	C672	QCHB1EZ-223	0.022MF 25V CER. CAP.	
	C683	QETBOJM-108N	1000MF 6.3V E. CAP.	
	C684	QETB1HM-475E	4.7MF 50V E. CAP.	
	C685	QETB1HM-475E	4.7MF 50V E. CAP.	
	C686	QETBOJM-108N	1000MF 6.3V E. CAP.	
		RESISTORS		
	R201	QRD161J-104	100K 1/6W CARBON RES.	
	R202	QRD161J-104	100K 1/6W CARBON RES.	
	R203	QRD161J-104	100K 1/6W CARBON RES.	
	R204	QRD161J-104	100K 1/6W CARBON RES.	
	R205	QRD161J-393	39K 1/6W CARBON RES.	
	R206	QRD161J-393	39K 1/6W CARBON RES.	
	R207	QRD161J-224	220K 1/6W CARBON RES.	
	R208	QRD161J-224	220K 1/6W CARBON RES.	
	R209	QRD161J-102	1K 1/6W CARBON RES.	
	R210	QRD161J-102	1K 1/6W CARBON RES.	
	R211	QRD161J-104	100K 1/6W CARBON RES.	
	R212	QRD161J-104	100K 1/6W CARBON RES.	
	R213	QRD161J-104	100K 1/6W CARBON RES.	
	R214	QRD161J-104	100K 1/6W CARBON RES.	
	R215	QRD161J-102	1K 1/6W CARBON RES.	
	R216	QRD161J-102	1K 1/6W CARBON RES.	
	R217	QRD161J-102	1K 1/6W CARBON RES.	
	R218	QRD161J-102	1K 1/6W CARBON RES.	
	R221	QRD161J-103	10K 1/6W CARBON RES.	
	R222	QRD161J-103	10K 1/6W CARBON RES.	
	R223	QRD161J-103	10K 1/6W CARBON RES.	
	R224	QRD161J-103	10K 1/6W CARBON RES.	
	R225	QRD161J-102	1K 1/6W CARBON RES.	
	R241	QRD161J-271	270 1/6W CARBON RES.	
	R242	QRD161J-271	270 1/6W CARBON RES.	
	R243	QRD161J-271	270 1/6W CARBON RES.	
	R244	QRD161J-271	270 1/6W CARBON RES.	
△	R245	QRZ0077-680	68 1/4W FUSIBLE RES.	
△	R246	QRZ0077-680	68 1/4W FUSIBLE RES.	
	R247	QRD161J-271	270 1/6W CARBON RES.	
	R248	QRD161J-271	270 1/6W CARBON RES.	
△	R249	QRZ0077-680	68 1/4W FUSIBLE RES.	
△	R250	QRZ0077-680	68 1/4W FUSIBLE RES.	
	R253	QRD161J-104	100K 1/6W CARBON RES.	
	R254	QRD161J-104	100K 1/6W CARBON RES.	

△	Item	Parts Number	Description	Area
	R255	QRD161J-393	39K 1/6W CARBON RES.	
	R256	QRD161J-393	39K 1/6W CARBON RES.	
	R257	QRD161J-103	10K 1/6W CARBON RES.	
	R258	QRD161J-103	10K 1/6W CARBON RES.	
	R259	QRD161J-103	10K 1/6W CARBON RES.	
	R260	QRD161J-103	10K 1/6W CARBON RES.	
	R261	QRD161J-303Y	30K 1/6W CARBON RES.	
	R262	QRD161J-303Y	30K 1/6W CARBON RES.	
	R263	QRD161J-123	12K 1/6W CARBON RES.	
	R264	QRD161J-123	12K 1/6W CARBON RES.	
	R265	QRD161J-472	4.7K 1/6W CARBON RES.	
	R266	QRD161J-472	4.7K 1/6W CARBON RES.	
	R267	QRD161J-183	18K 1/6W CARBON RES.	
	R268	QRD161J-183	18K 1/6W CARBON RES.	
	R269	QRD161J-912	9.1K 1/6W CARBON RES.	
	R270	QRD161J-912	9.1K 1/6W CARBON RES.	
	R271	QRD161J-243	24K 1/6W CARBON RES.	
	R272	QRD161J-243	24K 1/6W CARBON RES.	
	R273	QRD161J-103	10K 1/6W CARBON RES.	
	R274	QRD161J-103	10K 1/6W CARBON RES.	
	R275	QRD161J-333	33K 1/6W CARBON RES.	
	R276	QRD161J-333	33K 1/6W CARBON RES.	
	R279	QRD161J-681	680 1/6W CARBON RES.	
	R280	QRD161J-681	680 1/6W CARBON RES.	
	R301	QRD161J-222	2.2K 1/6W CARBON RES.	
	R302	QRD161J-222	2.2K 1/6W CARBON RES.	
	R303	QRD161J-473	47K 1/6W CARBON RES.	
	R304	QRD161J-473	47K 1/6W CARBON RES.	
	R305	QRD161J-621	620 1/6W CARBON RES.	
	R306	QRD161J-621	620 1/6W CARBON RES.	
	R307	QRD161J-393	39K 1/6W CARBON RES.	
	R308	QRD161J-393	39K 1/6W CARBON RES.	
	R309	QRD161J-474	470K 1/6W CARBON RES.	
	R310	QRD161J-474	470K 1/6W CARBON RES.	
	R311	QRD161J-104	100K 1/6W CARBON RES.	
	R312	QRD161J-104	100K 1/6W CARBON RES.	
	R313	QRD161J-331	330 1/6W CARBON RES.	
	R314	QRD161J-331	330 1/6W CARBON RES.	
	R325	QRD161J-102	1K 1/6W CARBON RES.	
	R341	QRD161J-104	100K 1/6W CARBON RES.	
	R342	QRD161J-104	100K 1/6W CARBON RES.	
	R343	QRD161J-104	100K 1/6W CARBON RES.	
	R344	QRD161J-104	100K 1/6W CARBON RES.	
	R361	QRD161J-104	100K 1/6W CARBON RES.	
	R362	QRD161J-104	100K 1/6W CARBON RES.	
	R363	QRD161J-103	10K 1/6W CARBON RES.	
	R364	QRD161J-103	10K 1/6W CARBON RES.	
	R365	QRD161J-472	4.7K 1/6W CARBON RES.	
	R366	QRD161J-472	4.7K 1/6W CARBON RES.	
	R371	QRD161J-471	470 1/6W CARBON RES.	
	R372	QRD161J-221	220 1/6W CARBON RES.	
	R381	QRD161J-471	470 1/6W CARBON RES.	
	R382	QRD161J-471	470 1/6W CARBON RES.	
	R385	QRD161J-471	470 1/6W CARBON RES.	
	R386	QRD161J-471	470 1/6W CARBON RES.	
	R387	QRD161J-471	470 1/6W CARBON RES.	
	R388	QRD161J-471	470 1/6W CARBON RES.	
	R389	QRD161J-471	470 1/6W CARBON RES.	
	R390	QRD161J-471	470 1/6W CARBON RES.	
	R393	QRD161J-471	470 1/6W CARBON RES.	
	R394	QRD161J-471	470 1/6W CARBON RES.	
	R395	QRD161J-471	470 1/6W CARBON RES.	
	R396	QRD161J-471	470 1/6W CARBON RES.	
	R397	QRD161J-471	470 1/6W CARBON RES.	
	R398	QRD161J-471	470 1/6W CARBON RES.	
	R641	QRD161J-102	1K 1/6W CARBON RES.	
	R642	QRD161J-102	1K 1/6W CARBON RES.	
	R643	QRD161J-163	16K 1/6W CARBON RES.	
	R644	QRD161J-393	39K 1/6W CARBON RES.	

Electrical Parts List (ENC-135)

△	Item	Parts Number	Description	Area
	R651	QRD161J-105	1M 1/6W CARBON RES.	
	R671	QRD167J-151	150 1/6W CARBON RES.	
	R672	QRD167J-152	1.5K 1/6W CARBON RES.	
	R673	QRD161J-271	270 1/6W CARBON RES.	
	R674	QRD167J-151	150 1/6W CARBON RES.	
	R675	QRD167J-152	1.5K 1/6W CARBON RES.	
	R676	QRD161J-271	270 1/6W CARBON RES.	
	R685	QRD161J-750	75 1/6W CARBON RES.	
	R686	QRD161J-473	47K 1/6W CARBON RES.	
	R687	QRD161J-331	330 1/6W CARBON RES.	
	R688	QRD161J-750	75 1/6W CARBON RES.	
	R689	QRD161J-331	330 1/6W CARBON RES.	
	R690	QRD161J-750	75 1/6W CARBON RES.	
	R691	QRD161J-750	75 1/6W CARBON RES.	
	R692	QRD161J-473	47K 1/6W CARBON RES.	
	OTHERS			
		EMW10680-003	PRINTED BOARD	
	J301	EMN00TV-423AJ2	PIN JACK	
	J302	EMN00TV-423AJ2	PIN JACK	
	J304	QNN0027-001	PIN JACK	
	J306	EMN00TV-227AJ2	PIN JACK	
	J371	QNS3501-020	PIN JACK	
	J601	EMN00YV-217A	PIN JACK	
	J602	EMN00TV-116A	PIN JACK	
	J603	EMN00TV-116A	PIN JACK	
	L671	EQL4004-R22	INDUCTOR	
	X641	ECXP8R0-001Z	CRYSTAL	
	CN302	EMV7163-004	CONNECT TERMINAL	
	CN304	VMC0163-021	CONNECT TERMINAL	
	CN306	EMV7163-012	CONNECT TERMINAL	
	CN307	EMV7163-005	CONNECTOR	
	CN308	EMV7163-010	CONNECT TERMINAL	
	CN312	EMV5163-004R	CONNECT TERMINAL	
	CN316	EMV5163-012R	CONNECT TERMINAL	
	CN317	EMV5163-005R	CONNECTOR	
	CN318	EMV5163-010R	CONNECT TERMINAL	
	CN361	EMV5163-007R	CONNECT TERMINAL	
	CN371	EMV7163-007	CONNECT TERMINAL	
	CN601	EMV7163-005	CONNECTOR	
	CN611	EMV5163-005R	CONNECTOR	
	CN702	EWS296-0134	SOCKET WIRE ASSY	
	CN841	EMV5163-007R	CONNECT TERMINAL	

Accessories list

Block No. **M2MM**

△	Item	Parts Number	Parts Name	Q'ty	Description	Area
	1	LET0023-001A	INSTRUCTION BOOK	1		EF, G
	1	LET0023-002A	INSTRUCTION BOOK	1		EN
	1	LET0023-003A	INSTRUCTION BOOK	1		BS
	1	LET0023-004A	INSTRUCTION BOOK	1		U, US, UT
	2	RM-SAV5RU	WIRE-LESS REMOTE CONTROL	1		BS, EF, EN, G
	2	RM-SAV5U	WIRE-LESS REMOTE CONTROL	1		U, US, UT
	3	R6SPTT-2ST	BATTERY	1		
△	4	ENZ2202-001	SIEMENS PLUG	1		US
△	4	ENZ2203-001	ADAPTOR PLUG	1		U, UT
	5	E309758-001	POLY BAG	1		
	-	BT-20066A	DISTRIBUTOR LIST	1		BS
	-	BT-20134	WARRANTY CARD	1		G
	-	BT-54003-1	WARRANTY CARD	1		BS
	-	E43486-340A	SAFETY SHEET	1		BS

Packing Materials and Parts Numbers

Block No. **M3MM**

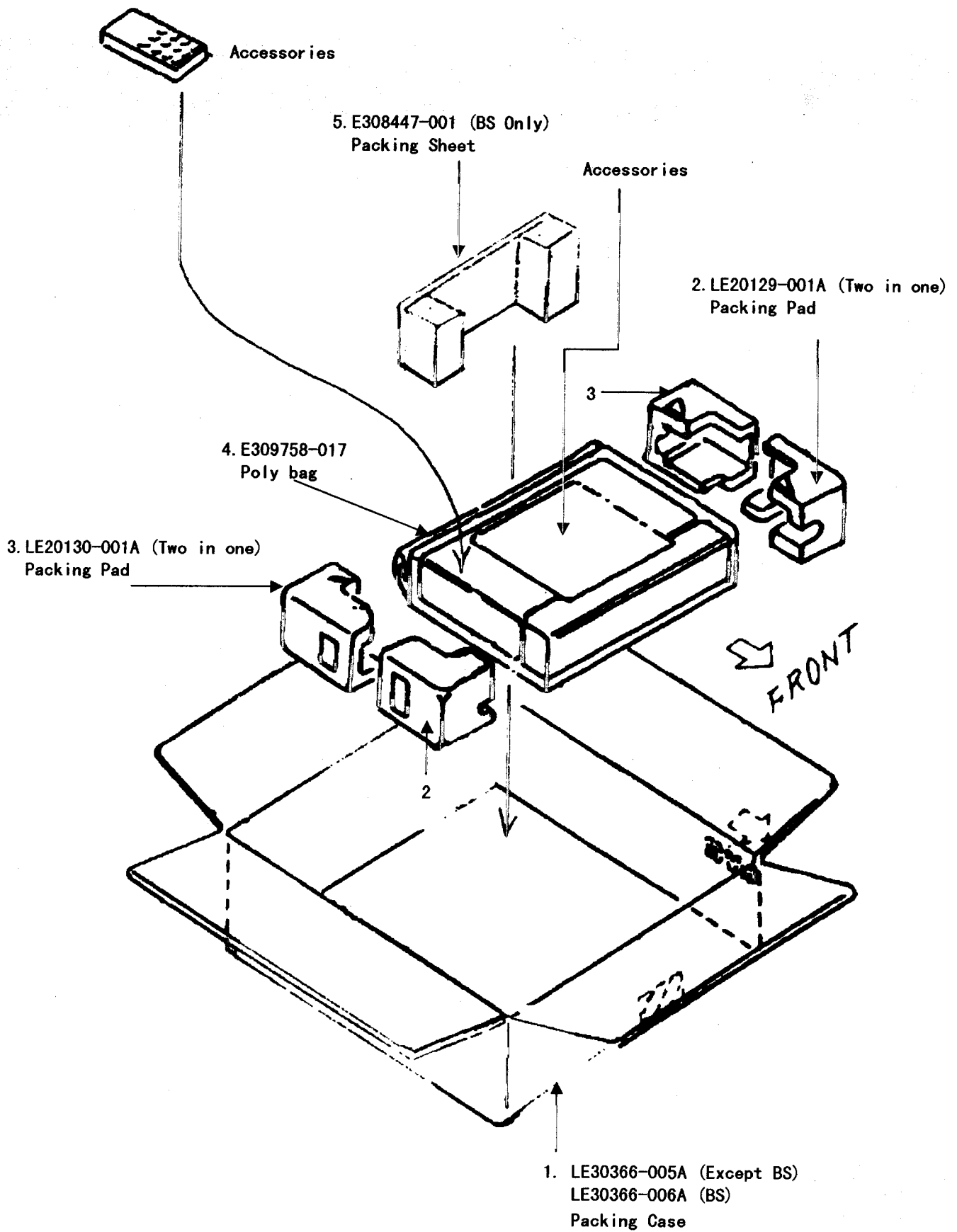

AX-V5BK

JVC

VICTOR COMPANY OF JAPAN, LIMITED
AUDIO DIVISION, 10-1, Chome, Ohwatari-machi, maebashi-city, Japan

(No.20636)

 Printed in Japan
9706(V)